



# The Upper Blinkwater Minigrid

South Africa, Eastern Cape  
Project Summary & Lessons Learned

Implemented by





# The Upper Blinkwater Minigrid

South Africa, Eastern Cape  
Project Summary & Lessons Learned



# Foreword

by **Olaf Lies, Minister for the Environment, Energy, Construction and Climate Protection of Lower Saxony**

The partnership with Eastern Cape Province is among the most active that Lower Saxony is involved in. This year, we look back at 25 years full of exchange and cooperation on various administrative and societal levels. One particularly positive example is chronicled in the present publication and we are proud to present it as a pilot project that has the potential to not only be developed further but to be replicated in different parts of the country and beyond.

The Ministry for the Environment, Energy, Construction and Climate Protection of Lower Saxony has been part of the process from the very beginning and has had the opportunity to witness and shape its growth from the first ideas and sketches into the comprehensive scheme it now constitutes. Lower Saxony was also present through its Representative to the Eastern Cape Province as well as the State Chancellery throughout its many stages. Main and most important partner on the South African side throughout the process was the Eastern Cape Department of Economic Development, Environmental Affairs and Tourism that held the lion share of responsibilities and coordination of the many stakeholders that were involved. Importantly, a broad range of actors from both societies like NGOs and academic institutes were part of the success as well. Through the involvement of the Deutsche Gesellschaft für Internationale Zusammenarbeit (GIZ) the federal level was included and allowed for a greater scale of the project. It was only together that this feat was achieved and there can be no doubt that this good example will advance future projects.

I am convinced that the hard work and dedication that were needed to accomplish the successful implementation of the initial plans will be reflected in the benefits it will bring to the local community. More than that, it could help leading the way to a new discussion about our energy systems, in the Eastern Cape as well as in Lower Saxony. It will unquestionably remain one of the focus areas of exchange and close cooperation.



**Olaf Lies**  
Minister for the Environment, Energy,  
Construction and Climate Protection  
of Lower Saxony

# Foreword

**by the Honourable Mlungisi Mvoko, Member of the Executive Council responsible for Economic Development, Environmental Affairs and Tourism, Province of the Eastern Cape.**

The year 1995 can be marked as a special date, it was the start of a very strong cooperation between Lower Saxony and the Eastern Cape, which resulted in many magnificent projects and realisations. Now in 2020, 25 years later, we are able to celebrate a new milestone in this long-standing partnership by the constructed Upper Blinkwater minigrid in the Raymond Mhlaba Local Municipality where electricity is provided through renewable and most importantly, sustainable energy resources. This project not only celebrates the excellent cooperation since that time, it also shows the relevance and importance of working together as different partners from different countries and cultures.

Through this collaboration, a small and isolated community has been uplifted to a new level, knowledge and expertise has been exchanged, new friendships were made and the blueprints for future minigrid development in South Africa has been set out. The relevance to the greater energy access picture can't be expressed enough as this milestone project is not only an enabler for development, growth and prosperity, it is a driver to push towards a 100% energy access rate in the province and the whole nation. We truly hope this cooperation can inspire many new projects and future partnerships, and that they can have the same outstanding atmosphere between the different partners as experienced with this project.

Let's celebrate this milestone and hope that 25 years later we can look back again to a province with lights shining in every household.



**Honourable M.G Mvoko**  
Member of the Executive Council  
Finance, Economic Development, Environmental Affairs and Tourism

# Foreword

by **Bandile Ketelo**, Mayor of the Raymond Mhlaba Municipality

The Raymond Mhlaba Municipality considerably expressed its exuberant appreciation on the completion of the Upper Blinkwater Minigrid Project. As an institution, we take pride to have partnered with Lower Saxony, BMZ, our provincial government and multiple further partners as we successfully leveraged a catalyst project of this magnitude.

We soundly affirm that this developmental trajectory excellently comprehended our utmost resolve of providing quality services to our own communities. Imperatively, it enabled our commitment to effectively transform the socio-economic conditions of our people and positively shaped the outlook of the entire village. To this effect, the material change to the living conditions of our own people has been greatly significant. We make bold to assert that the Upper Blinkwater Minigrid Project injected a unique developmental contribution to the people of Upper Blinkwater, giving new opportunities for both youth and woman in particular. Certainly, young people are the major beneficiary as they have fully utilised this prime opportunity to equally empower themselves academically and continue to expand their horizons. The maximum access to the digital world as well as the applicable opportunities to unlimitedly utilise the electric appliances has extremely transformed material living conditions of the community of Upper Blinkwater. The traditional domesticated approach employed by women in servicing their own households has been replaced by the modern day avenues as women are no longer required to harvest woods for cooking purposes.

Notable, our unwavering commitment to the provision of quality services to our communities remains our key priority. The strategic partnerships with partners such as GIZ continues to foster our zeal to meaningful contribute in bettering the living conditions of our people including promoting good corporate governance.

A handwritten signature in black ink, appearing to read 'Bandile Ketelo', is written over a series of horizontal lines. The signature is stylized and somewhat abstract.

**Bandile Ketelo**  
Mayor of the Raymond Mhlaba Municipality

## List of abbreviations

|                |   |
|----------------|---|
| <b>BFE</b>     | Bundestechnologiezentrum für Elektro- und Informationstechnik<br>(Federal Technology Centre for Electrical Engineering and Information Technology)  |
| <b>BLP</b>     | Federal-State-Pilot-Programme   |
| <b>BMZ</b>     | Federal Ministry for Economic Cooperation and Development (Germany)   |
| <b>COGTA</b>   | Department of Cooperative Governance and Traditional Affairs  |
| <b>CLO</b>     | Community Liaison Officer   |
| <b>CPSC</b>    | Community Project Steering Committee  |
| <b>CSIR</b>    | Council for Scientific and Industrial Research  |
| <b>DEDEAT</b>  | Eastern Cape Department of Economic Development, Environmental Affairs and Tourism  |
| <b>DEULA</b>   | Bundesverband der Deutschen Lehranstalten für Agrartechnik e.V.<br>(Federal Association of German Training Institutes for Agricultural Engineering) |
| <b>DLR</b>     | Deutsches Zentrum für Luft- und Raumfahrt (German Aerospace Center)   |
| <b>DMRE</b>    | Department of Mineral Resources and Energy (South Africa)   |
| <b>DRDAR</b>   | Eastern Cape Department of Rural Development and Agrarian Reform  |
| <b>ECRDA</b>   | Eastern Cape Rural Development Agency   |
| <b>FBE</b>     | Free Basic Electricity  |
| <b>GEF</b>     | Global Environment Facility   |
| <b>GIZ</b>     | Deutsche Gesellschaft für Internationale Zusammenarbeit<br>(German Corporation for International Cooperation)                                       |
| <b>HCD</b>     | Human Capacity Development  |
| <b>IRP</b>     | Integrated Resource Plan  |
| <b>MISA</b>    | Municipality Infrastructure Support Agency  |
| <b>MU</b>      | Ministry of Environment of Lower Saxony   |
| <b>NERSA</b>   | National Energy Regulator of South Africa   |
| <b>NMU</b>     | Nelson Mandela University   |
| <b>REIPPPP</b> | Renewable Energy Independent Power Producer Procurement Programme   |
| <b>RMLM</b>    | Raymond Mhlaba Local Municipality   |
| <b>SAGEN</b>   | South African and German Energy Programme (GIZ)   |
| <b>SANEDI</b>  | South African National Energy Development Institute   |
| <b>SAWEP</b>   | South Africa Wind Energy Programme  |
| <b>UFH</b>     | University of Fort Hare   |
| <b>UNDP</b>    | United Nations Development Programme  |



# Table of Contents

|  |           |
|--|-----------|
| Foreword Lower Saxony                  | 3         |
| Foreword Eastern Cape                  | 4         |
| Foreword Raymond Mhlaba Municipality   | 5         |
| List of abbreviations                  | 6         |
| <b>1 Mission</b>                       | <b>8</b>  |
| 1.1 Introduction                       | 9         |
| 1.2. Participation & Collaboration     | 14        |
| 1.3. Electrification                   | 21        |
| 1.4. Improving Lives                   | 23        |
| <b>2 Project</b>                       | <b>24</b> |
| 2.1. Community                         | 25        |
| 2.2. Design & Development              | 28        |
| 2.3. Monitoring & Evaluation           | 43        |
| <b>3 Impact</b>                        | <b>50</b> |
| 3.1. Working Together                  | 51        |
| 3.2. Community Engagement              | 52        |
| 3.3. Clean Energy & Social Development | 54        |
| <b>4 Joint Publications</b>            | <b>56</b> |
| Joint Publications                     | 57        |
| <b>5 Lessons Learned</b>               | <b>58</b> |
| Lessons Learned                        | 59        |
| References                             | 63        |

# Mission



## 1.1 Introduction

*“During the design phase of the project, collaborating/researching extensively with several suppliers helped us make sure our designs for the first municipal mini-grid in SA would be a success.”*

(participant's reflection)

The Upper Blinkwater smart, renewable minigrid project is based on a trilateral agreement between the Eastern Cape Province, the federal state of Lower Saxony and GIZ Germany, acting on behalf of the Federal Ministry for Economic Cooperation and Development (BMZ) of Germany. In Lower Saxony, climate protection by promoting renewable energies and reducing the consumption of fossil fuels is one of the political priority areas. Climate change is a global challenge that needs to be addressed in cross-border efforts and partnerships. Drought-stricken South Africa is one of the countries most severely affected by climate change already. At the same time, 25 % of the communities in the rural areas in the Eastern Cape still do not have access to electricity.

In 2011 South Africa embarked on an ambitious renewable energy programme. This followed the promulgation of the Integrated Resource Plan (IRP) 2010-2030 by the Department of Mineral Resources and Energy (DMRE), which envisaged that 42 % of all new-build generation capacity would be procured from renewable energy sources. This progressive policy decision laid a firm foundation for the introduction of the much-lauded Renewable Energy Independent Power Producer Procurement Programme (REIPPPP).

The REIPPPP initiative has resulted in the procurement of 6.3 GW of new renewable energy capacity to date. The latest iteration of the IRP envisages a significant share of the new generation capacity to be from renewable energy. This provides an opportunity to determine the potential of expanding this sector outside the REIPPPP model. Off-grid renewable energy technologies in particular may help bridge the gap in the government electrification programme by offering an alternative electrification model for rural settlements that are currently underserved by the grid electricity.

This project is based on a strong cooperation between Lower Saxony and the Eastern Cape Province, which have since 1995 had a long-standing partnership. The cooperation is characterized by a diverse portfolio of projects and a committed collaboration. The partnership was officially consolidated in a new Joint Declaration in October 2015 on the occasion of the 20th anniversary of the partnership (Joint Declaration of 15.10.2015). This engagement between Lower Saxony and Eastern Cape created a strong political will to implement a minigrid electrification project.

Following a joint concept development process together with the Eastern Cape Government in 2016, the state of Lower Saxony decided to participate in the Federal-State-Pilot-Programme (BLP), funded by the Federal Ministry for Economic Cooperation and Development (BMZ) and implemented by GIZ. The BLP carries out projects between German federal states and partner countries with the aim to make better use of the competencies and experience of the German federal states for development cooperation. The partners from Lower Saxony (Ministry of Environment, DLR and DEULA) and GIZ thus together developed a proposal for the minigrid project in South Africa which makes use of the experience of the Lower Saxonian partners and which was to be financed jointly by Lower Saxony, the Eastern Cape and the BMZ.

The goal of the main project is to develop and test a decentralized, sustainable energy supply concept for the rural population in South Africa. The main activity is the development and implementation of a hybrid minigrid system based on renewable energies and diesel backup in a selected community in the Eastern Cape Province. With the installation of photovoltaic systems in the community in the Eastern Cape, practical knowledge about the feasibility and necessary framework conditions for a sustainable and decentralized energy supply shall be gained and, if the evaluation is positive, expanded.

The target group is the population of a small community in the Eastern Cape in South Africa. During a delegation visit in May 2016, more than two potential project communities were selected after an initial pre-selection process. After further defining the specifications of the technical, social and political criteria, the community of Upper Blinkwater, with 67 households, was selected for piloting this project.

The project was implemented by the GIZ BLP programme in Hamburg in cooperation with partners in Lower Saxony (DLR and DEULA). In the Eastern Cape the project has been implemented and coordinated by the Eastern Cape Department of Economic Development, Environmental Affairs and Tourism (DEDEAT) with support from the GIZ SAGEN project (South African and German Energy Programme).

The Upper Blinkwater project aims at improving living conditions in the rural areas and promoting renewable energy. It has been a pilot in many ways, being the most complex project that has been conducted within the Eastern Cape–Lower Saxony twinning agreement so far. Many challenges have been overcome, which showcases the solid cooperation. As a result, the village of Upper Blinkwater has

been electrified 10 years earlier than expected, bringing along development and job opportunities for the entire community.

Being a first of its kind, the project is a new institutional model for rural electrification in South Africa. Apart from uplifting the community of Upper Blinkwater itself, the project demonstrates how successful cooperation between federal, regional and international actors is possible. Furthermore, it points out that long-term commitment and intrinsic motivation of all partners are fundamental influences on the outcome of a project. The government of Lower Saxony is looking forward to continuing this flourishing partnership with similar projects.

## KEY PROJECT OUTCOMES

- Having a fully working renewable energy hybrid minigrid consisting of PV panels, batteries and a diesel generator
- Providing sustainable energy to a deep rural village which would otherwise not have been electrified within the next 10 years
- Implementing a service delivery project through government support
- Cooperating with various funding, regulatory, institutional and developmental partners that each play a critical role.
- Pioneering a minigrid as a service delivery project on a technical, social and institutional level.
- Paving the way for future minigrid development and defining the much-needed policies, licensing processes and public-private partnership to open up the minigrid space in South Africa
- Designing a minigrid that is able to be grid-connected and inject excess energy to avoid load-shedding
- Showcasing the importance of social facilitation

## Project Process

What started in 2015 as a first idea and brainstorming between Lower Saxony and the Eastern Cape has culminated in a fully functional minigrid which provides reliable electricity to the community of Upper Blinkwater (UB) of Raymond Mhlaba Municipality, in the Eastern Cape Province of South Africa. It took five years, from the initial idea and conception to the construction and commissioning of the UB minigrid.

This process for constructing a relatively small installation can be considered quite a lengthy process. Nevertheless, the five years were justified considering that the construction of a minigrid in a municipal setting was an unfamiliar undertaking for all stakeholders involved. Looking back to the total project process, it can be mapped out in the following figure:

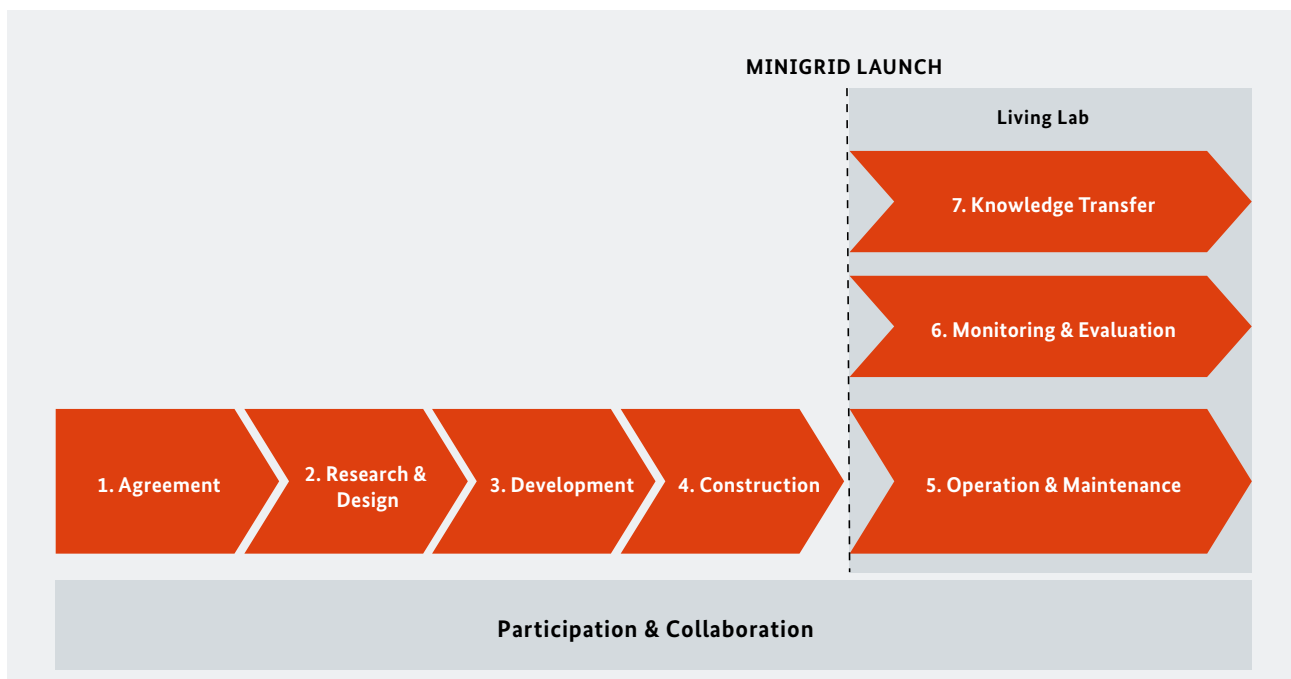

Figure 1: Project process diagram

As the figure shows, we can identify a total of seven phases, with possible extra phases still to come.

### **Phase 1: Agreement 2015**

The Eastern Cape and Lower Saxony have been collaborating in close partnership since 1995, after the first Joint Declaration of Intent on the cooperation was signed by former Lower Saxony Prime Minister Gerhard Schroeder and Eastern Cape Premier Raymond Mhlaba. When a delegation of business owners, universities and other institutions from Lower Saxony, led by then Deputy Prime Minister Stefan Wenzel, visited the Eastern Cape for a renewing of the twinning agreement this unique initiative was born as well. Both guests and hosts were immediately intrigued by the idea of developing a pilot project of „off-the-grid“-solutions from renewable energies together, in order to speed up rural electrification in South Africa. A joint brainstorming session was held spontaneously after a long day's programme. Although at that moment the exact details of what would be constructed were available only from a high-level perspective, it was the start of exploring the minigrid space in South Africa.

### **Phase 2: Design 2015 – 2017**

Following the signing of the Joint Declaration, research started into the various aspects of a minigrid such as ownership models, permit requirements, capital structuring, topographic surveys, technical modelling, etc. Eastern Cape DEDEAT, in close collaboration with the Raymond Mhlaba Local Municipality, the Lower Saxony ministry of environment (MU), DEULA-Nienburg and the DLR institute, undertook an in-depth analysis of the minigrid environment in South Africa, which together with numerous stakeholder meetings and workshops began to define an ideal minigrid design for the area. Different locations were proposed, and the Upper Blinkwater was decided on as the final location through the use of different selection criteria. After different social surveys conducted by the municipality and service providers through DEDEAT, a Tier 4 level energy access was decided and with support of the DLR the first sizing of all the different components was defined. The minigrid would be a hybrid minigrid with PV, batteries and a diesel genset. Through the help of DEULA and

the Raymond Mhlaba Development Agency, other measurements such as Human Capacity Development were defined in a more detailed way. The basics of the minigrid were defined and approved by all the various stakeholders.

### **Phase 3: Development 2016 – 2020**

Once the primary questions such as location and size were defined, the development of the minigrid took place in terms of

- 1. Defining the different capital structures from different donors such as DEDEAT, ECRDA, Lower Saxony and BMZ**  
As each donor has to follow their own administrative processes, different budgets contributed to the final construction of the minigrid. Unfortunately, this also meant the minigrid needed to be split into different parts so each budget could contribute to a discrete part, which brought its challenges in terms of procurement, oversight and handover.
- 2. Clarifying the landscape for different permits and licenses needed, and obtaining the ones necessary**  
Given the absence of a policy framework for minigrids, it wasn't clear which permits and licences should be obtained to fully legalize the installation. In the end, two licences were needed: a distribution licence through NERSA, which also acts as the tariff licence, and a water usage licence from the department of water and sanitation for the installation of wooden electricity poles in the wetlands. A generation licence wouldn't be needed in the first phase, according to NERSA.
- 3. Engaging with a social facilitator to support all the different processes**  
The social facilitation, which was one of the main success factors, started from the first engagement with the community to ensure full transparency, achieve buy-in from the community and manage expectations.

4. Developing technical terms of references for owner's engineer, the EPC contract and O&M
- As mentioned in previous points, working with different funders requires different procurement processes to obtain the stated objectives. Various terms of references were written to contract the owner's engineer, the EPC contractors and social facilitators, which also includes the following up of each contract.

#### Phase 4: Construction 2018 – 2020

The first part of the construction phase started in 2018 with the installation of the PV panels and fencing. The second part of the construction was put out to tender in the same year but started only in 2019. Because of many delays in design modifications, equipment compatibilities and procurement processes, it took more than two years to construct the minigrid, which in a perfect scenario through one tender tied to one source of funding could be finished in around six months.

#### Phase 5: Operation & Maintenance 2020 – 2021

As the municipality will be the owner, the contractor that was responsible for the construction is also responsible for the O&M for one year and a half, which gives the opportunity to engage with the municipality and transfer knowledge to the electrical department in how to operate and maintain the minigrid.

#### Phase 6: Monitoring & Evaluation 2020 – 2021

With the current system, all information is being logged through a monitoring and evaluation framework that captures all technical, social and financial data this minigrid is producing.

#### Phase 7: Knowledge transfer 2020

This document, which is one of the many outcomes of the UB minigrid, is intended to enable knowledge transfer. Through various meetings and workshops, a lot of information was generated which should not be lost during the process. Transferring knowledge, especially to the municipality, has been crucial in the process of allowing full ownership.

#### Phase 8:

As this is still not being formalized, phase 8 could consist of different project ideas such as:

- ▶ Development of productive use of energy and local business development
- ▶ Development of a financial model to link the LCOE to the currently used tariff structure
- ▶ Capacity building and skills development of the municipal electricity department for full ownership of the minigrid in a technical, financial and social way

## 1.2. Participation & Collaboration

*“All stakeholders involved were very motivated early on from conception. Willingness to participate from different partners, lot of interest from other organizations such as ECRDA, SAWEP, UNDEP. Great interaction with the community”*  
(participant's reflection)

Partnerships have been the bedrock of South Africa's energy transition. As a country, South Africa has succeeded in creating the largest and most competitive renewable energy market in Africa. Germany and numerous other partners have been giving support in shaping the policy vision that gave birth to the country's renewable energy industry as we know it today.

This unique initiative was born in 2015, when a delegation of business owners and research and educational other institutions (DLR, BFE, DEULA) from Lower Saxony, led by then Deputy Prime Minister Stefan Wenzel, visited the Eastern Cape. Both guests and hosts were immediately intrigued by the idea of developing a pilot project of “off-the-grid” solutions from renewable energies together, in order to speed up rural electrification in South Africa.

The Upper Blinkwater smart renewable community grid project has been the core project in this area of cooperation. Building on this, in 2016 both governments signed the “Eastern Cape – Lower Saxony



**Provincial level:** The relationship between Lower Saxony/Germany and the Eastern Cape dates back to 1995, when the two provinces established bilateral relations. The first Joint Declaration of Intent on the cooperation was signed by former Lower Saxony Prime Minister Gerhard Schröder and Eastern Cape Premier Raymond Mhlaba. Since then, the twinning agreement has been renewed twice. In the course of the years, new areas of cooperation were introduced, among them the cooperation on climate protection and environmental management.

**National level:** In 2008, the two countries established a new Focal Area on Energy and Climate under the Technical Cooperation Agreement, which gave birth to the South African–German Energy Programme (SAGEN), amongst others. The collaboration of Provincial Government of Eastern Cape and State of Lower Saxony with the Upper Blinkwater project is thus a welcome addition and development in pursuance of this long-standing relationship.

Climate Protection Initiative”. This specific agreement is aimed at furthering the mutual striving for tangible and in-depth cooperation in the field of energy efficiency and climate protection.

South Africa owes a great deal of gratitude to the Global Environment Facility (GEF), whose support for the second phase of the South Africa Wind Energy Programme (SAWEP 2) has made it possible for the DMRE together with the UNDP Country Office to contribute towards integrating a wind component into the Upper Blinkwater project.

### Interaction and collaborative engagement of partners & contributors

The project involves many stakeholders and contributors who are key to the success of the project. Funding



Partners, stakeholders and contributors involved in the project

## Main partners

The Province of  
the Eastern Cape



The Province of the Eastern Cape with its capital Bisho is the second-largest province in the country. In this project it is the main political representation of SA and one of the key funders.

Lower Saxony



The State of Lower Saxony was involved in this project through several of its bodies. The Ministry of Environment of Lower Saxony is the main political representative from Lower Saxony in this project and was involved in project steering and project funding. It also played a major role in the first conceptualization and design of the project. The Lower Saxony Ministry of Internal Affairs and Sport gave support with coordination.

RMLM



Raymond Mhlaba Local Municipality (RMLM) is the local administration for the community of Upper Blinkwater and responsible for communal energy management. They were involved from the beginning in the development of the design of the project community management, tariff discussions and more. RMLM will be the future owner of the grid.

GIZ



Die Deutsche Gesellschaft für Internationale Zusammenarbeit (GIZ) implements the Federal-State-Pilot Programme on behalf of BMZ. It is a global programme, implementing projects between German federal states and development projects and partner countries. In the minigrid project between Lower Saxony and Eastern Cape, GIZ is responsible for the project implementation, management and financing.

was made available through the Lower Saxony, BMZ, DEDEAT, ECRDA and the municipality. The technical partners from Lower Saxony (DLR and DEULA) were proposed by the Ministry of Environment in Lower Saxony. The main partners in the Eastern Cape were identified by DEDEAT with the administration of the RMLM. Further partners from South Africa were added during the duration of the project, such as Afri-

coast as the owner's engineer, Eya Bantu and Likhanye consulting for the facilitation process and NMU and UFH for the monitoring of the minigrid.

The consortium development was an ongoing process throughout project implementation and had a different focus during each stage.



DEDEAT



The Department of Economic Development, Environmental Affairs and Tourism (DEDEAT) is responsible for public administration of economic development, environmental affairs and tourism in the Eastern Cape. It is the main political representative and involved in project steering, project management and coordination and project funding of the minigrad.

ECRDA



The Eastern Cape Rural Development Agency (ECRDA) belongs to the public administration in Eastern Cape and contributed project funding.

BMZ



The German Federal Ministry for Economic Cooperation and Development (BMZ) is the main political actor and donor in the field of development cooperation in Germany. It commissioned GIZ to implement the Federal-State-Pilot Programme (BLP), which aims to make better use of the competencies and experience of the German federal states for development policy.

Lower Saxony



The State of Lower Saxony was involved in this project through several of its bodies. The funding for the project was provided by the Lower Saxony State Chancellery.

# South Africa

Partners, stakeholders and contributors involved in the project

Africoast



The engineering company Africoast was the main consulting company for the development of the technical design and supervised the construction of the minigrid as the owner's engineer assigned by DEDEAT.

COGTA



The Eastern Cape department for cooperative governance & traditional affairs.

CSIR



The Council of Scientific and Industrial Research was engaged with the wind component as main service provider to design the wind component and elaborate the terms of references for the wind part.

DMRE



The Department of Mineral Resources and Energy is one of the main stakeholders for the wind component and an important participant during the original project design phase.

DRDAR



The Department of Rural Development and Agrarian Reform of the Eastern Cape was involved during the original project design phase.

ESKOM



Eskom as the public utility for electricity in South Africa was involved during the project design phase, as the distribution side of the minigrid is Eskom compliant.

Eya Bantu



The engineering company Eya Bantu provided engineering services for the development of the technical design and facilitated the development of communal energy management assigned by DEDEAT.

# South Africa

## Partners, stakeholders and contributors involved in the project

Lamo Solar



The engineering company Lamo Solar constructed the minigrid in Upper Blinkwater in a consortium with Greenmax Energy. Lamo Solar was responsible for the engineering, procurement and construction of the installation (EPC contract) and operation and maintenance until the municipality takes over.

Likhanye Engineering



The engineering company Likhayne Consulting provided engineering services for the development of the technical design and facilitated the development of communal energy management assigned by DEDEAT.

MISA



Municipal Infrastructure Support Agency (MISA) is responsible for communal energy management and was involved in the development of the energy tariff system.

NERSA



The National Energy Regulator of South Africa (NERSA) is a regulatory authority and responsible for the regulation of energy industry in accordance with government laws, policies, standards. It was involved in the development of the tariff system for the minigrid.

RMDA



Raymond Mhlaba Development Agency is a rural development institution in RMLM and was involved in the organization of communal meetings and development and implementation of HCD measures.

SAGEN



The South African-German Energy Programme (SAGEN) is funded by BMZ and implemented by GIZ in South Africa. The SAGEN project supports the South African Department of Energy in the development of approaches to promote grid-connected on-grid photovoltaic systems. The SAGEN project provides a development advisor to DEDEAT, which plays an integral part in the project coordination in South Africa.

Partners, stakeholders and contributors involved in the project

## South Africa

SAWEP



The South African Wind Energy Programme (SAWEP) is a multi-year technical assistance project, funded by the Global Environment Facility (GEF), supporting the Government of South Africa in promoting the large-scale commercialisation of wind energy. SAWEP is supporting the CSIR in providing technical assistance with the wind component and the procurement of the wind turbines, including O&M, capacity building and M&E support.

Shared Energy Management



SEM was the appointed contractor for the installation of the PV panels (75kWp)PV panels (75kWp)

Universities

NMU / UFH



The University of Fort Hare (UFH) and Nelson Mandela University (NMU) are two well-known teaching and research institutions in the Eastern Cape. Both universities were involved in the scientific monitoring of the minigrid and the elaboration of key performance indicators and their testing as well as the collection of monitoring data.



University of Fort Hare  
Together in Excellence

Partners, stakeholders and contributors involved in the project

## Germany

DEULA-Nienburg



DEULA is an educational institution in the field of agriculture. In the project it was responsible for the development and implementation of the HCD concept for rural agricultural activities in the pilot community.

DLR



DLR Institute for connected energy systems is a research institute in the field of renewable energy. In the project it was responsible for: baseline analysis, scenario design on energy needs and provision, grid design and modelling of scenarios, and the scientific supervision of the project.

## Interaction of Partners

*“Strong political will and support in Lower Saxony and Eastern Cape created a strong will to implement project.”*

(participant's reflection)

At the beginning of the project, two kick-off workshops were held in Lower Saxony and in the Eastern Cape to coordinate all cooperating partners and clarify tasks and responsibilities. In addition, a household survey was carried out in all 67 households in the pilot municipality of Raymond Mhlaba to determine the energy requirements and to inquire about interests and training needs for human capacity development.

During the two workshops all relevant aspects of project implementation and financing were discussed with all partners, and necessary adjustments were identified and jointly approved. The workshop in Lower Saxony was helpful to decide and make

early changes in the project design and to create an outline of the project's goals. A common decision was made to change the original project design (reduce pilot villages to one and complexity of project design to leave out biogas production) to create a realistic and viable project.

These workshops created an excellent cooperation structure and enabled strong engagements between the partners from South Africa and Germany / Lower Saxony and Eastern Cape. The partners from both sides were continuously involved in the evolution and adaptation of the project through many other meetings, workshops and trainings in Lower Saxony as in the Eastern Cape. This spirit of collaboration, mutual support and respect has always been one of the core success factors of the project.

## 1.3. Electrification

### Challenge: Universal “clean” electricity access

Goal 7 of the Sustainable Development Goals advocates universal access to affordable, reliable, sustainable and modern energy services. Access to energy is an essential prerequisite to achieving many sustainable development goals that extend far beyond the energy sector, such as eradicating poverty, increasing food production, providing clean water, improving public health, enhancing education, and creating economic opportunity [1].

According to the World Bank’s report [2], from 1997 to 2017, the proportion of the global population with access to electricity increased from 78 % to 89 %, with the number of people living without electricity dropping to just below 1 billion [1]. More than half of this population lives in Sub-Saharan Africa, and rapid population growth is projected to outpace grid expansion. The electrification rate in Sub-Saharan Africa is 67 %, and it drops as low as 28 % in rural areas [3]. In many countries national utilities lack the resources to finance grid extensions to remote rural areas, where low levels of electricity consumption and limited ability to pay often make these extensions uneconomical. The average cost of extending the grid to rural consumers in Africa is estimated at \$2,000/connection [4].

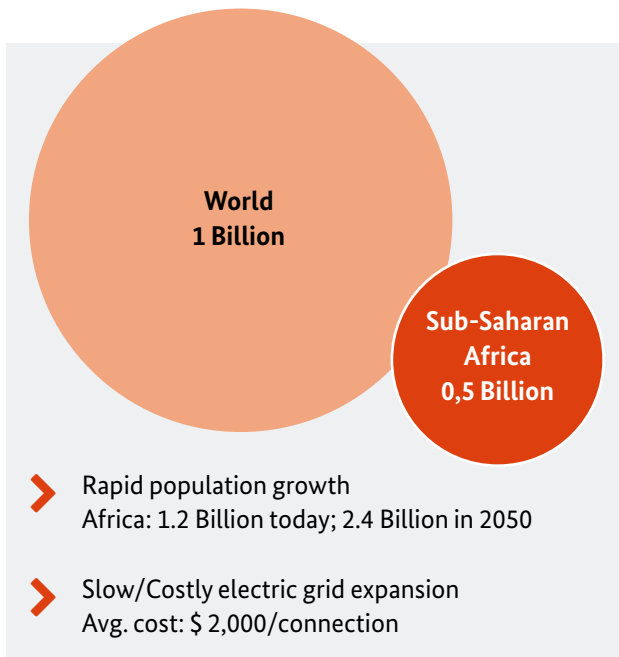

Figure 2: Population without electricity access / population growth / cost of grid expansion

For South Africa, the electrification of the whole country is an important national target. Over the span of the last three decades the electricity access has improved astonishingly from around 40 % to 85 % today, leaving around 15 % of all households still not electrified due to challenges of extending the rather expensive grid infrastructure to the widespread rural areas. According to the Integrated Resource Plan 2019 (IRP2019), which is South Africa’s electricity infrastructure development plan from the Department of Energy, South Africa still had 3-million households without access to grid-based electricity in 2019 [7]. The Eastern Cape has the lowest grid connection level in South Africa with a rate of 64.5 % [8]. Based on estimates from the local sources, 25 % of all communities in the Eastern Cape will be connected to the grid in eight to 15 years at the earliest. As a result, the inhabitants of these villages economically and socially lag behind and migrate to other areas.

The South African government objective is to provide access to electricity to all of its citizens. The project represents a model for supplying high-quality energy to deep rural villages which are not due to be connected to the national electricity grid within the next five to ten years. This in turn brings the developmental opportunities for the rural community forward by a decade.

### Opportunity: renewable energy minigrids

Renewable energy hybrid minigrids are a suitable alternative for providing reliable, environmentally friendly supply to remote communities. A consistent and affordable supply of energy can open new possibilities for socioeconomic progress. The International Energy Agency projects that minigrids and stand-alone off-grid systems will play key roles in extending electricity to many rural areas in Africa that do not have access to national grids [5].

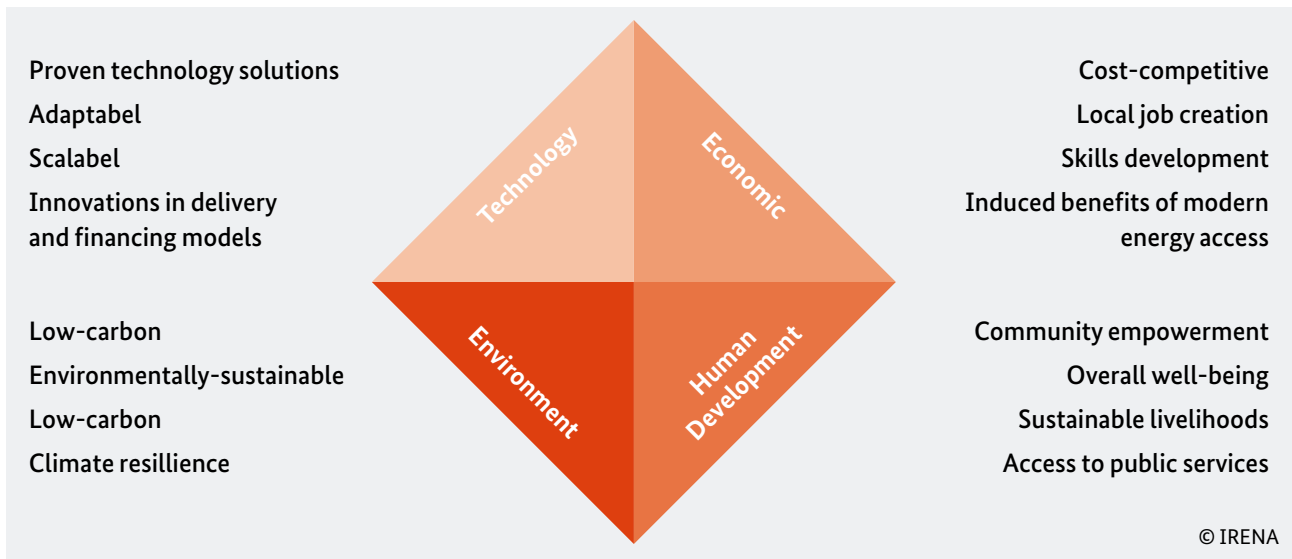

Figure 3: Renewable energy minigrid benefits  
*Adopted & adjusted from IRENA [12] page 7*

Africa has emerged as a dynamic, fast-advancing centre for renewable minigrids. The deployment of PV technologies has been a key driver of growth in minigrid capacity. The abundance of the resource, the distributed nature of technology and decreasing costs are leading solar PV to become a viable alternative for meeting a wide range of electricity services in areas largely underserved by the national grid. The cumulative capacity has increased from 231 MW in 2008 to nearly 1.2 GW in 2017 [5]. The World Bank estimates that 140 million rural Africans will gain access to electricity served by minigrids by 2040 [6].

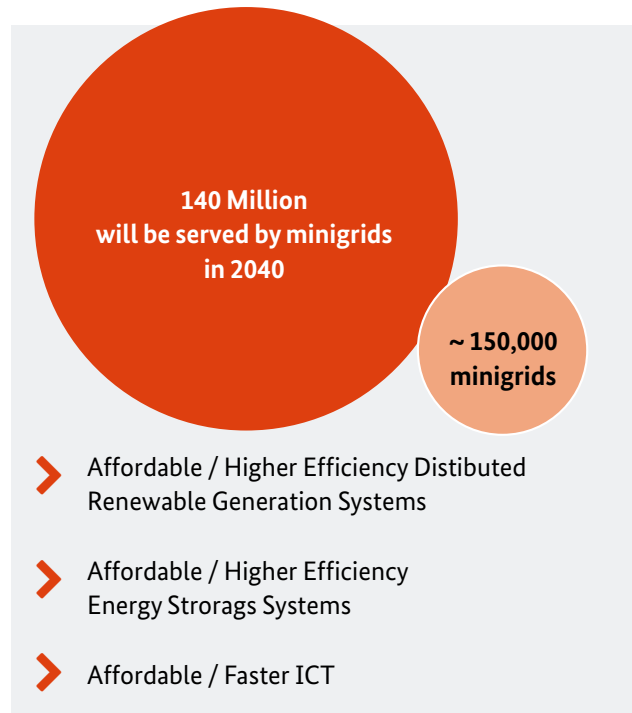

Figure 4: Renewable energy minigrid prospects and supporting technologies

The IRP2019 indicates that the cost of providing grid connections has increased as the served communities become more remote. There is therefore a need to quantify the off-grid and minigrid opportunity and put in place the necessary frameworks for accelerated development [7].



## Taking advantage of renewable energy resources to provide clean energy

South Africa has approximately 51.7GW of generating capacity (2019), of which about 3.7GW (7%) is currently renewable energy and 38.0GW (73%) is coal. The Department of Energy has committed South Africa to increasing renewable energy generation to 24.7% of mix by 2030, through its Integrated Resource Plan [9]. The potential for the use of solar energy is extremely favourable and the sunshine duration of up to 2,500 hours/year [10]. Solar irradiance is also relatively uniform across the country, and forms the best renewable resource available for minigrids. The following figure shows the solar irradiation ( $\text{kWh}/\text{m}^2$ ) for South Africa [11].

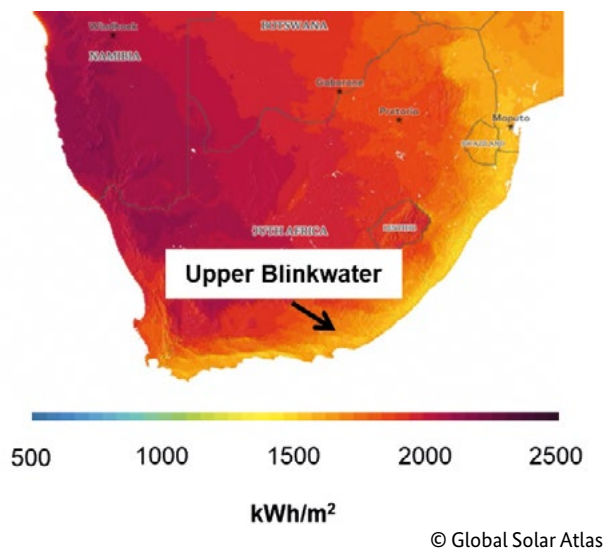

Figure 5: Solar energy resources (solar irradiation  $\text{kWh}/\text{m}^2$ )

## 1.4. Improving Lives

The Upper Blinkwater project aims to resolve the social challenges, alleviate the energy poverty gap, including poverty eradication, and stimulate economic growth. The participation and involvement of rural communities in the decision-making process substantially contributes to the effectiveness of the off-grid electrification programme. The local support structure is a crucial factor in the application of mini-grids, which perpetuates the long-term sustainability of off-grid for the effective delivery of energy services to rural communities.

Access to electricity enables improvement in the economic growth and social stability of the country. Decentralized energy generation can provide an opportunity of optimal sustainable and meaningful energy distribution to remote and rural communities, harnessing the renewable energy resources to stabilize the socio-economic development of the growing population.

In the future, the establishment of local structures to operate, maintain and administer all of the systems and the formation of small businesses promoted an entrepreneurial culture and provided local technical assistance when minor breakdowns occur. Eradication of energy poverty can be sustained by developing local skills and entrepreneurship.



Figure 6: Electrified household

# Project

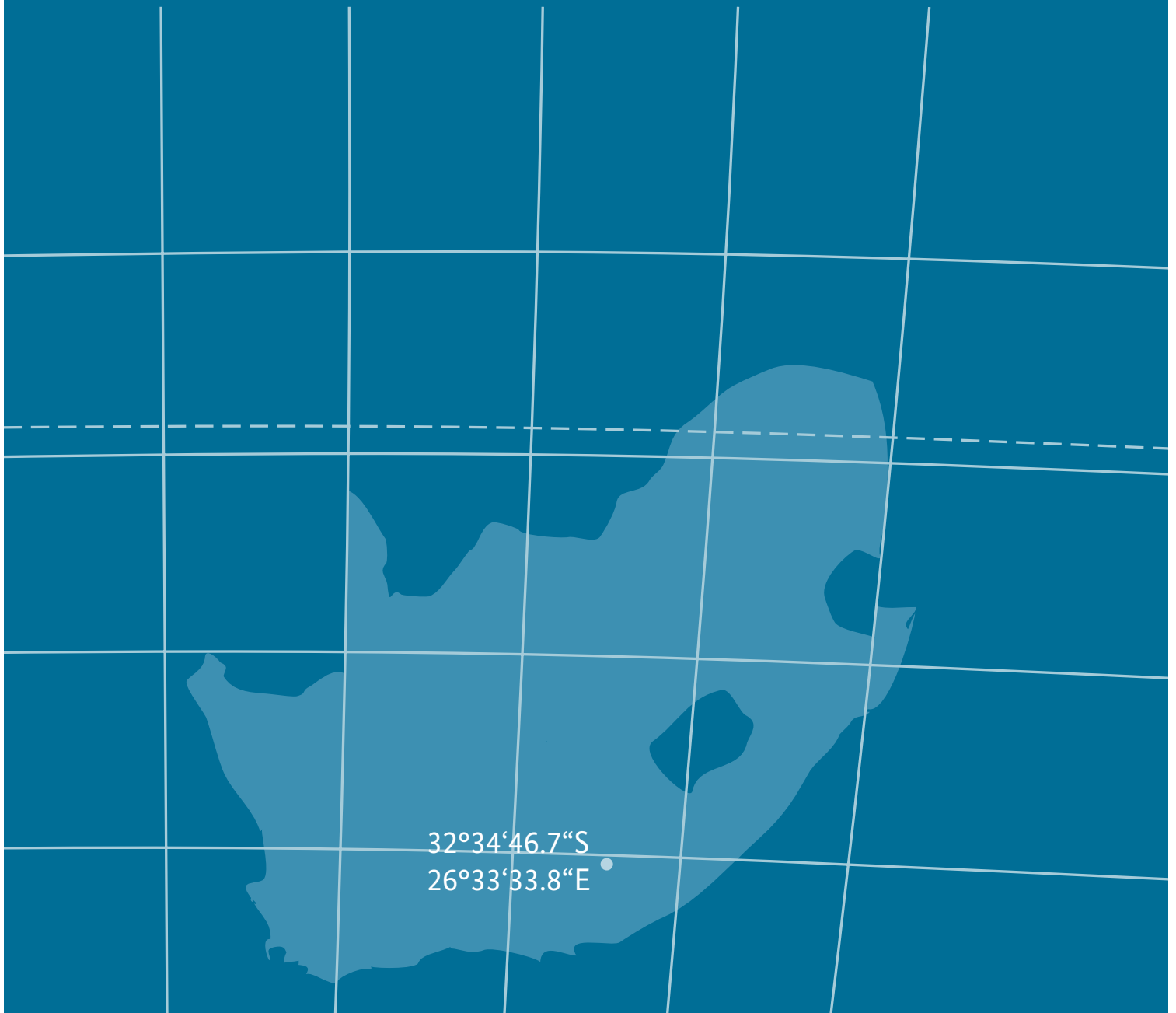

## 2.1. Community

*“Communication is the key, first and foremost with the village community. Focusing on the community and the assignment of a social facilitator played a big part for the project to become a success story”*

(participant’s reflection)

Upper Blinkwater is a small rural village located within the Raymond Mhlaba Local Municipality, in the Province of the Eastern Cape, South Africa, situated on a higher plateau (height res. 900 m above sea level) at 32°34'46.7"S 26°33'33.8"E. The village is not grid-connected. Moreover, there is little prospect

of electrifying the village in the next ten years. Upper Blinkwater is geographically isolated, with sparsely scattered settlements and inadequate infrastructure development with limited accessibility.

The rough and environmentally sensitive terrain, low electricity demand, low population density, high cost of grid extension, and remote location of the village hinder the electrification of the village. However, the electrification of previously unserved communities significantly affects socio-economic development, especially among lower-income households.



Figure 7: Upper Blinkwater location



Figure 8: Upper Blinkwater aerial view



© Google © CNES/Airbus, Maxar Technologies, Kartendaten © 2020 AfriGIS (pty) Ltd

Figure 9: Upper Blinkwater satellite map

Demographic Data (2019)

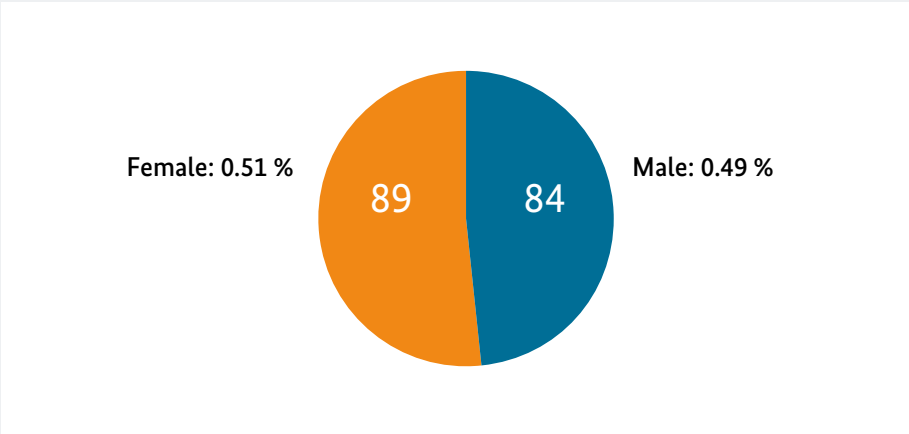

Figure 10: Community population by gender

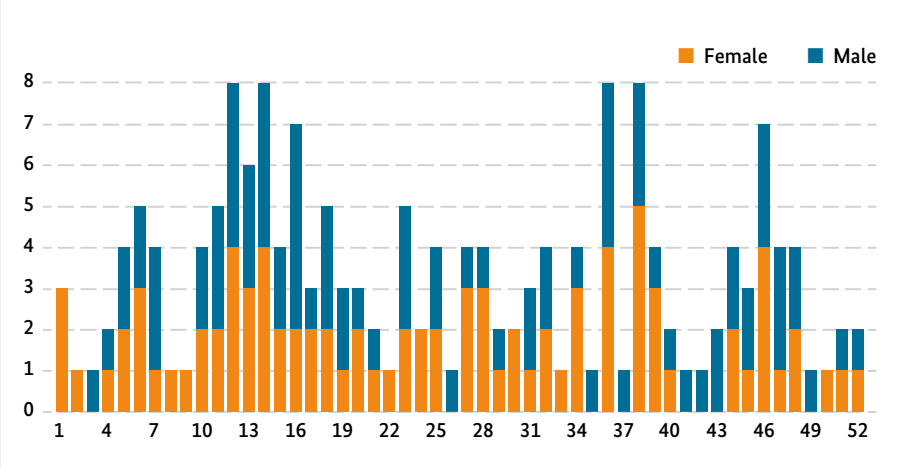

Figure 11: Number of household residents by gender

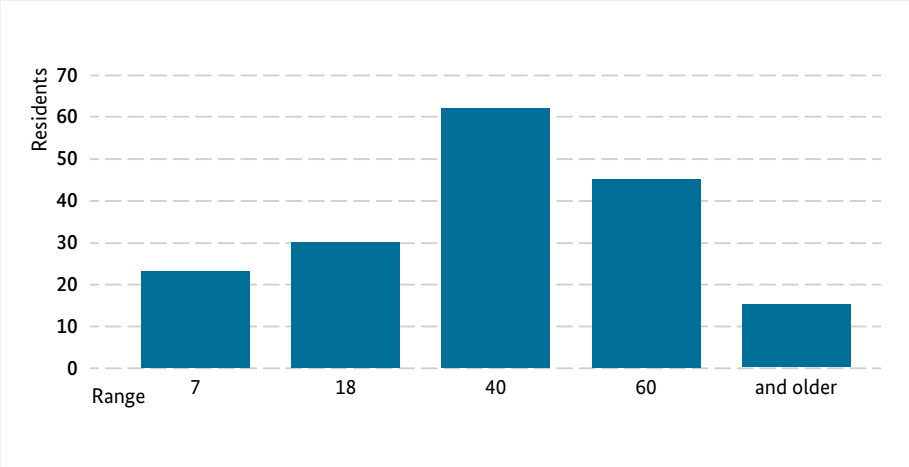

Figure 12: Age histogram

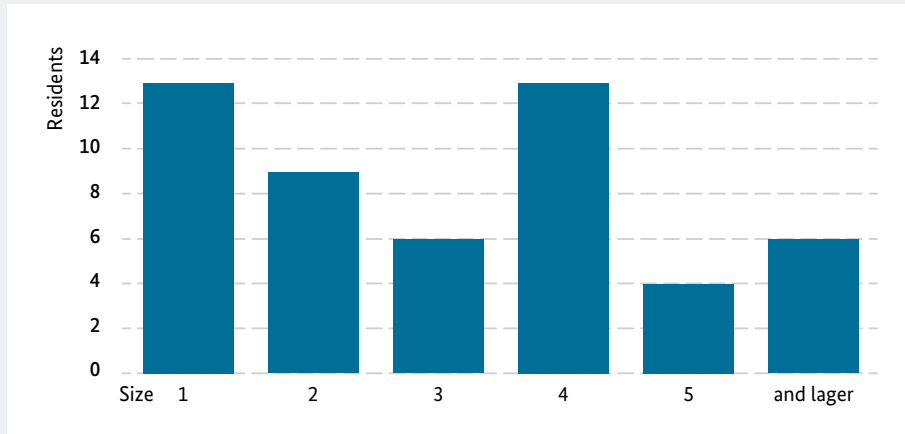

Figure 13: Family size histogram

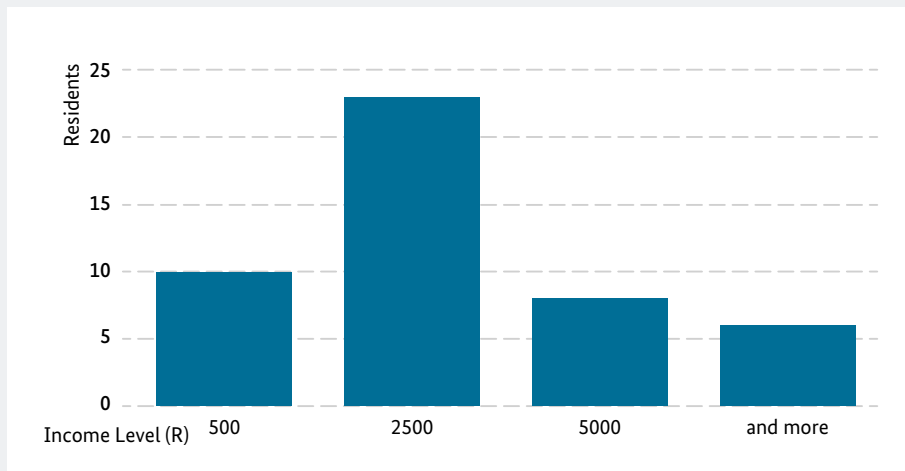

Figure 14: Household income histogram

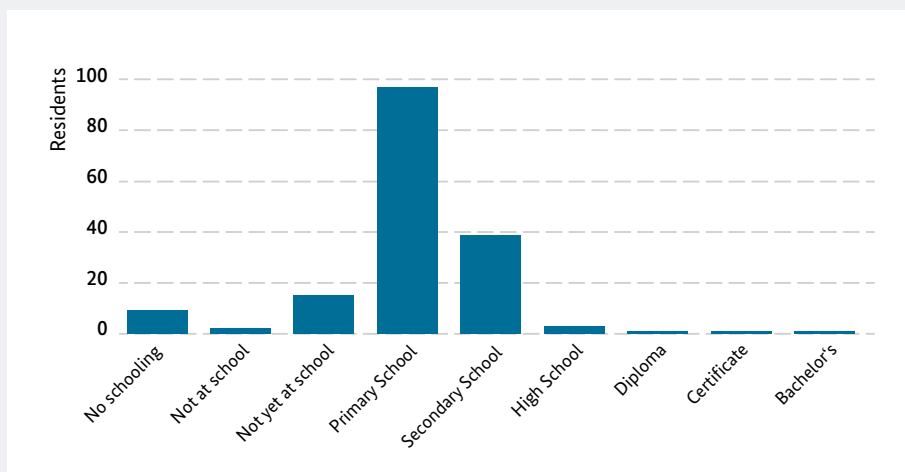

Figure 15: Education histogram



## 2.2. Design & Development

*“The Upper Blinkwater minigrid project can provide a template for replication of hybrid minigrid systems in South Africa and region”*

(participant’s reflection)

As part of a joint project between South Africa’s Eastern Cape province and Germany’s state of Lower Saxony, co-funded by BMZ (Federal Ministry for Economic Cooperation and Development) and co-implemented through GIZ (Deutsche Gesellschaft für Internationale Zusammenarbeit: German Corporation for International Cooperation), a renewable hybrid minigrid was designed and developed in the village of Upper Blinkwater in the Raymond Mhlaba Local Municipality, Eastern Cape, South Africa for a rural community of 67 households, with 90% living off social grants and enjoying no access to the main national grid [10].

The aim of the project is to demonstrate a service delivery solution for an economically, institutionally and environmentally sustainable energy supply to non-electrified rural communities.

The development of sustainable isolated power systems requires a multi-stage iterative process. In the first step, the ideas, goals, hopes and expectations of the actors are identified and recorded. In the following, these expectations were compared with the underlying local situation. Weather and climate conditions directly influence the chosen technology of hybrid minigrids. Previous projects were analysed, and important findings were gained mainly from their failure.



Figure 16: Village household

This analysis showed that it was not the technical decisions that were decisive in the failure of the projects to be sustainable, but local acceptance, knowledge and awareness, as well as the implementation in the structure of rural communities and municipalities. Therefore, the technical decisions are subordinate to considerations about social acceptance, estimation of the future load profile and climate realities. Cost analyses based on the technical layout and expected load profile close the circle to social acceptance.

## Social Acceptance

Early and honest communication with villagers is essential to their acceptance of the initiative. The biggest threats to minigrids are theft (due to economic constraints) and vandalism of the system due to resentment or the perception of discrimination. Lack of understanding of technology often leads to lasting damage to infrastructure in the case of small defects. Therefore, right from the beginning of the project a

All stakeholders and funding agencies agreed on a targeted supply quality equivalent to the Eskom national grid supply quality. The main points of argument are:

- Energy access is considered a fundamental right in South Africa
- Energy access is seen as a driving force for economic development
- The minigrid must not be perceived as a second-best solution in public perception
- A high rate of acceptance and identification of villagers with the minigrid is necessary to protect the installation from vandalism and theft

facilitation manager was used to ensure a constant dialogue. Facilitation activities help to identify concerns, needs and prospects as well as the demand for workshops and education activities.

## Baseline Study

*“Extensive research and communication with local project engineer and contractor made it possible to identify the right equipment.”*

(participant’s reflection)

Upper Blinkwater is a small village in Raymond Mhlaba Municipality in the province of the Eastern Cape, South Africa. In the first quarter of 2017, with the help of a community questionnaire, data on the current use of energy carriers and their consumption patterns, income structure and available financial budget for electric energy were collected. In addition, residents were surveyed regarding their expectations for a power system, and their preferred electrical applications. At the time of the survey, the village was composed of 67 households and a primary school. There are no shops or businesses. 67 households with different household compositions participated in the survey.

A selection of results from the community baseline study is presented below.

## Energy carriers used

Several different energy carriers are in use in Upper Blinkwater. These include collected wood, paraffin for cooking, lighting and heat, candles, the use of small batteries and car batteries as well as the usage of LPG for stoves and generators. The share and distribution of energy carriers within the village are displayed in Figure 17.

Every household uses wood as a free energy resource, in the sense of not taking into account the cost of time taken to collect it. Paraffin and candles are

the second and third most used energy carriers. 66 households stated that they use paraffin for cooking and heating of water; 62 also use it for additional lighting, while only one household didn't use paraffin at all. The cost of paraffin per month is between R30 and R800. 11 households consume LPG for either a generator or a stove, and 25 households use batteries (one-time use and rechargeable). The batteries are mainly used for torches and lights as well as power supplies for radios.

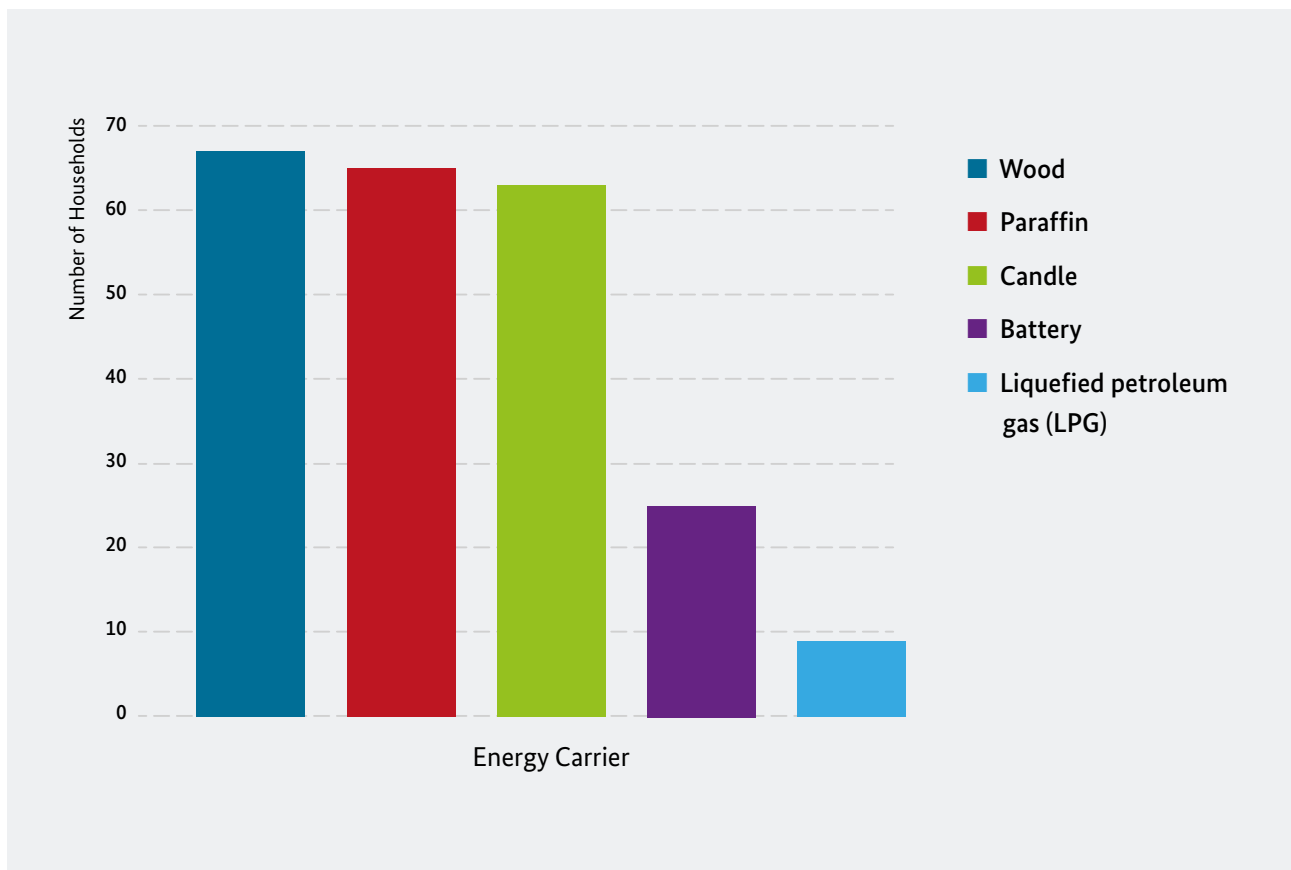

Figure 17: Consumption of energy carriers



## Activities the villagers are interested in

The answers to the survey on future activities also focus on gardening. The highest priority for most households (51) is gardening. Another nine households assess gardening as being a high priority, whereas only three households perceive gardening as less important or not important at all. More than 60% of the villagers would like to do learning activities with children. The third-highest interest is in the processing of fruits and vegetables from gardening. The production of maize follows some distance behind.

Service work such as sewing and haircutting are not favoured by Upper Blinkwater villagers (see figure below), but becoming an electrician was identified as an area of interest.

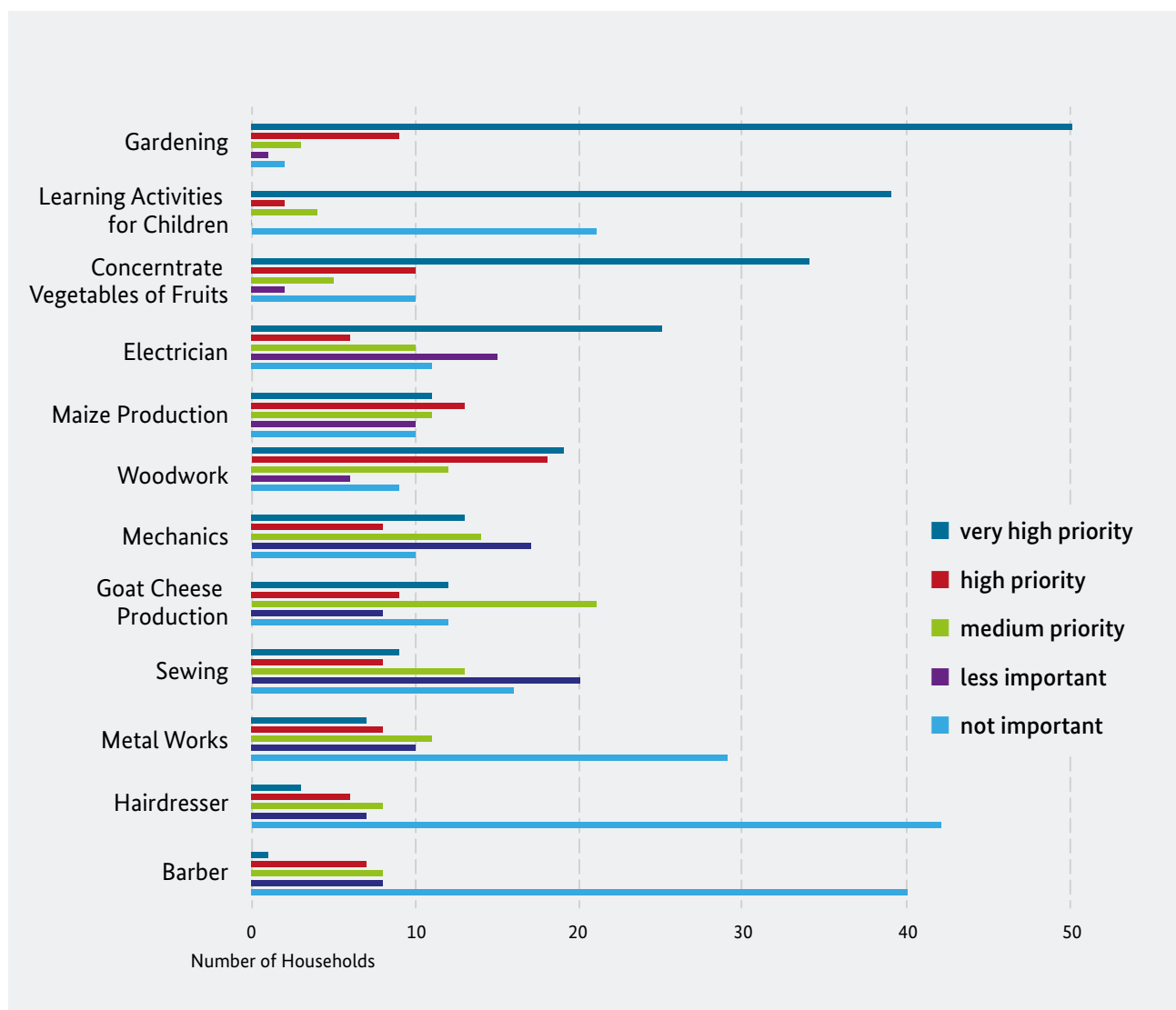

Figure 18: Interest of the villagers for different future activities

## Preferences for electrical appliances

When asked about the need for electrical appliances, the focus was clearly on refrigerators, kettles, electric stoves, TVs and radios, followed by lights, phone chargers, microwaves and streetlights (see figure below). Most residents favour the use of an electric stove above a stove fired by gas (82%), while only one house-

hold had a preference for a gas stove. But 60% would use a gas stove if it would allow them to use electrical energy for more appliances. 6.5% would rather use gas than electrical power if it is cheaper.

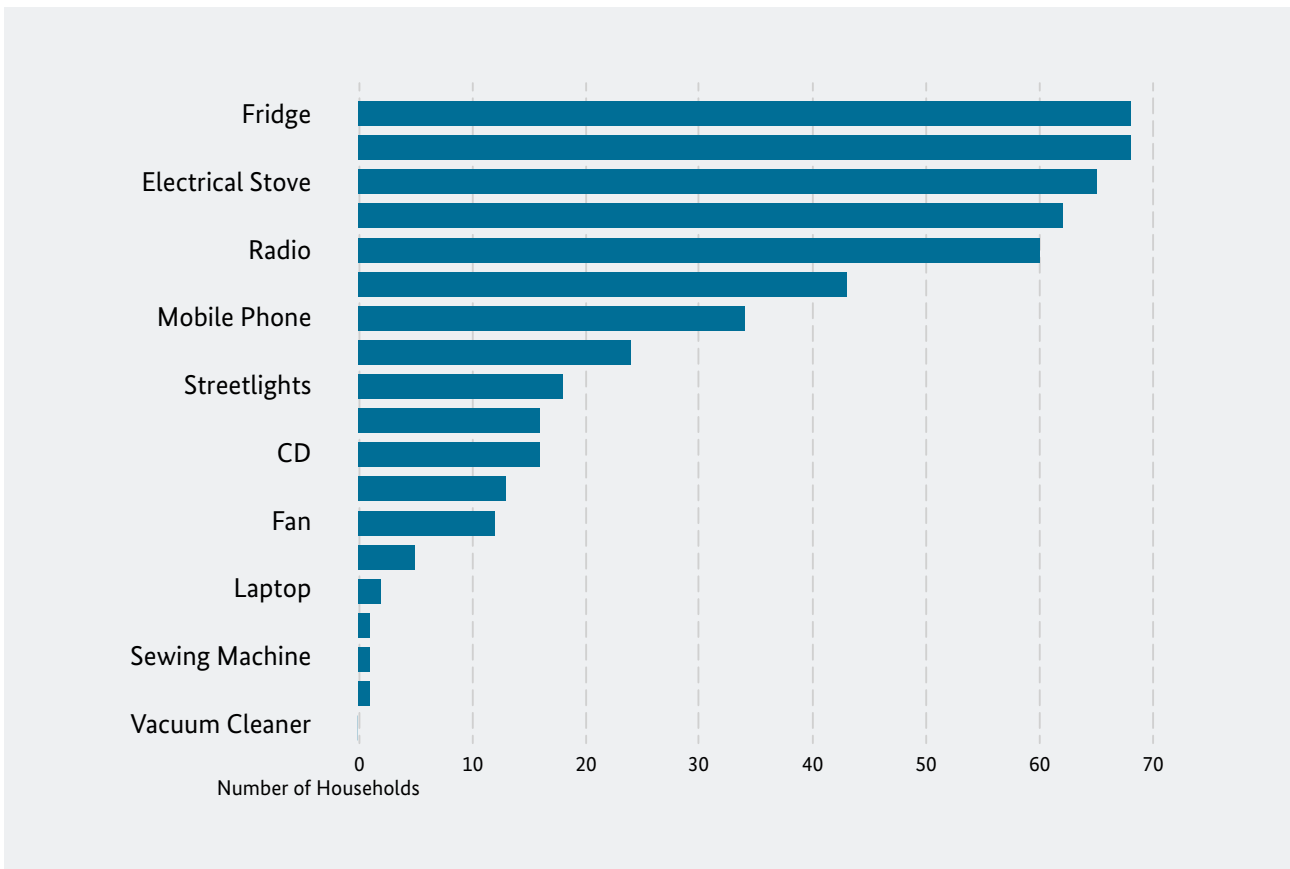

Figure 19: Highest priority in electrical applications

## Investments to increase the quality and opportunities in the village

Modern and digital learning equipment for the school, especially access to an electronic library, are very important for Upper Blinkwater Village members (more than 55%).

Second and third in terms of importance are appliances for growing plants, and warehousing and preserving garden products (cooling container and water pumps). Only about 33% favour a TV for Upper Blinkwater.

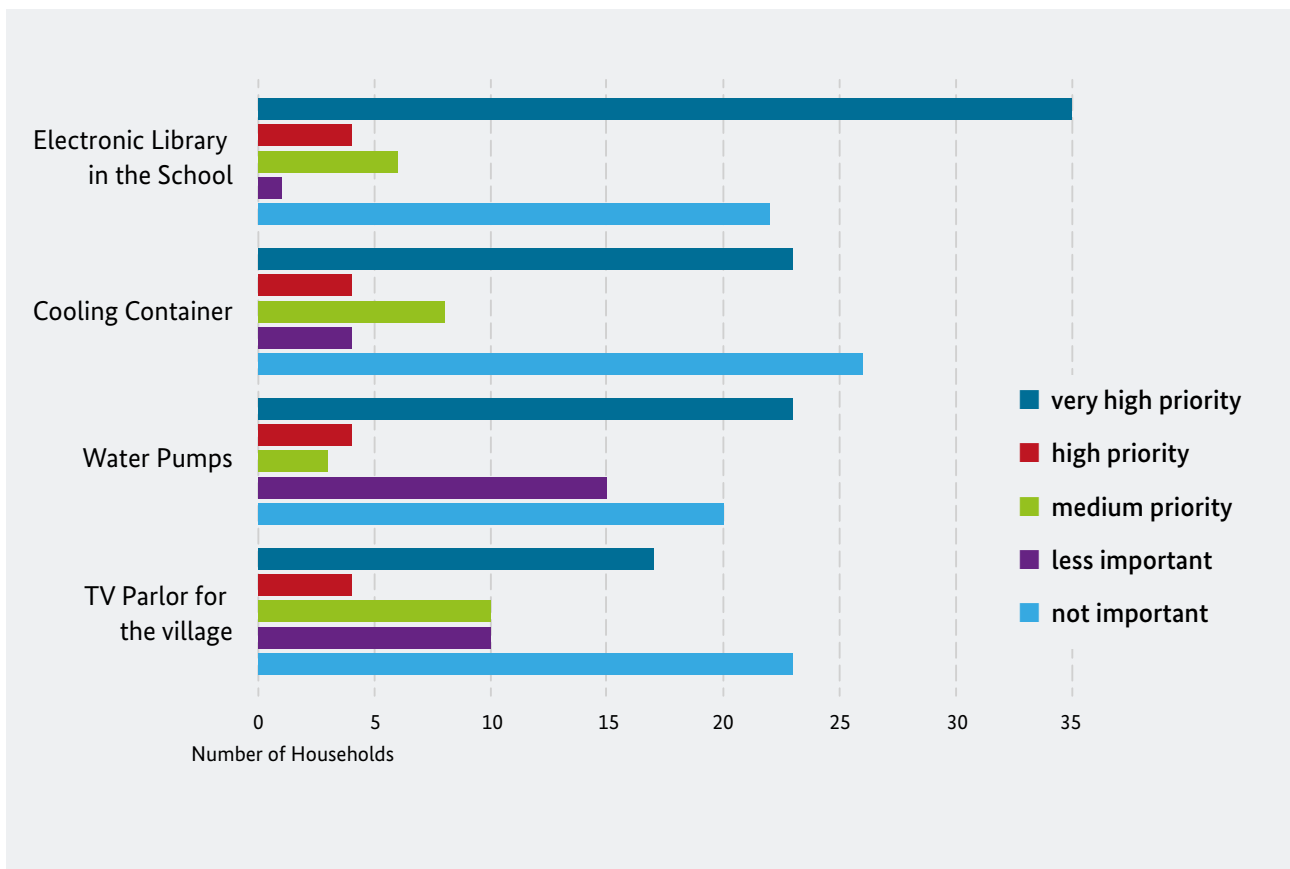

Figure 20: Preferred investments

## Renewable Energy Resources

The site is located in the area of the so-called sunbelt countries and experiences mean solar irradiance of 210 kWh/m<sup>2</sup> and a yearly irradiance of 1,840 kWh/m<sup>2</sup>a. The daily solar energy yield ranges between 1.2 kWh/m<sup>2</sup> and 9.9 kWh/m<sup>2</sup>. Seasonal variation of the day length in this area is small, and times between sunrise and sunset

vary between 9.75h and 14.25h. Daily and monthly irradiance is displayed in Figure 21. The normal temperature range at Upper Blinkwater is between 2.6°C and 31.8°C, with a median temperature of 17.5°C based on the long-term average.

| IRRADIANCE           |                          |
|----------------------|--------------------------|
| maximum power        | 1290 kW/m <sup>2</sup>   |
| mean power           | 209.8 kW/m <sup>2</sup>  |
| minimum daily energy | 1.2 MWh/m <sup>2</sup> d |
| mean daily energy    | 5 MWh/m <sup>2</sup> d   |
| maximum daily energy | 9.9 MWh/m <sup>2</sup> d |
| yearly energy        | 1.8 GWh/m <sup>2</sup> y |

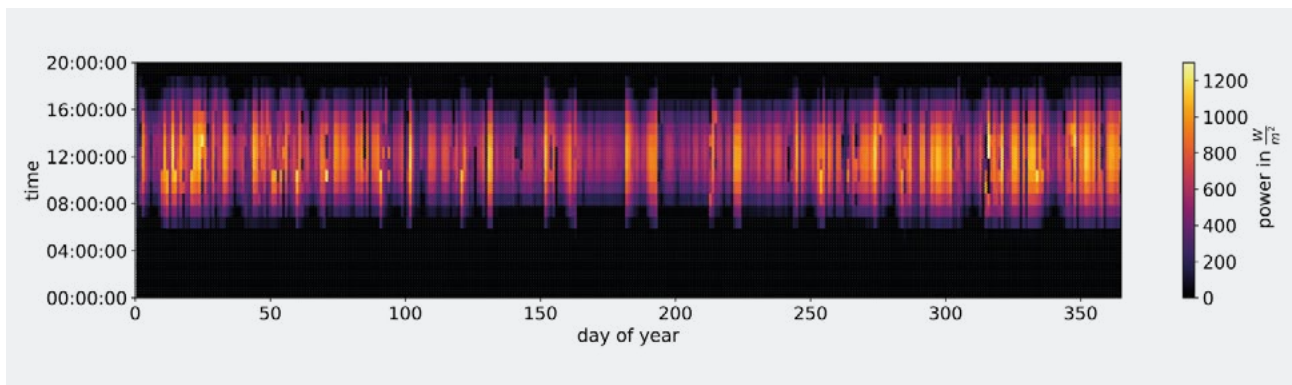
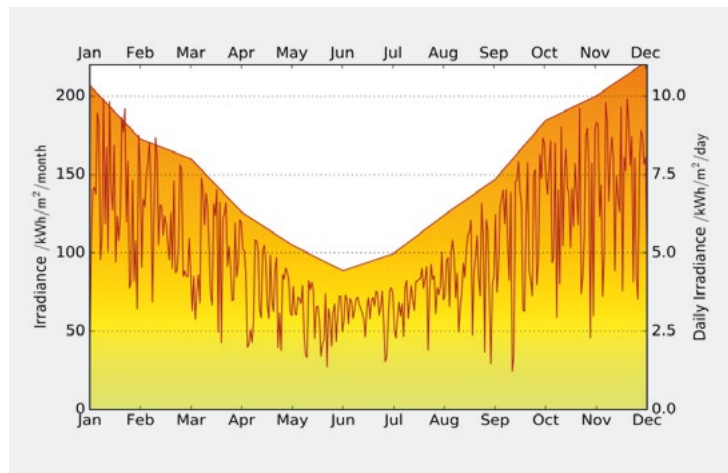

Figure 21: Solar irradiance throughout the year

## Load Profile Estimation

For the design of a hybrid minigrid in a previously unelectrified region with high poverty, a good estimate of the expected power consumption in power and energy as well as the consumption behaviour over the day is necessary. At the present time there are no reliable household profiles for households after initial electrification availability. Socio-cultural, financial and political differences complicate the creation and transferability of standardized household load profiles across continental and national borders and climate zones. Taking local value chains into account, human capacity development can stimulate a commercial use of electricity and vice versa. Outer constraints like limited budget and the target of reproducibility on an economic basis limit the possible system setup.

Binary metrics such as whether a household has an electricity connection and whether a household cooks with non-solid fuels are not helpful in understanding the phenomenon of expanding energy access and how it impacts socio-economic development. The SE4ALL Multi-tier Framework (MTF) developed by the World Bank Group redefines energy access to fill the gaps in the binary access.

As illustrated in the table below, the MTF acknowledges that energy access is a spectrum of service levels (or

tiers) consumed by households, productive engagements and community facilities. It also focuses on the quality of energy service.

The targeted supply level was Tier 4, i.e. a minimum power capacity of 800W per household and a minimal consumption of 3.4 kWh per day, with a minimal availability of 16h per day. For the following calculations a load profile of 67 households at the lower range of Tier 4 were assumed. The number of actual households connected to the minigrid will have a major influence on the available power and energy per household.

From the generation side the following requirements were considered in the design stage:

- ▶ The main power generation should be based on a renewable source
- ▶ Emissions of greenhouse gases (e.g. CO<sub>2</sub>) and fossil fuel consumption should be limited to a minimum
- ▶ A total blackout, e.g. the failure of the full minigrid power supply, should be avoided
- ▶ The availability of power should be ensured

| TIER | POWER                | HOUR/DAY | APPLICATION                                 |
|------|----------------------|----------|---|
| 0    | No Electricity       |          | No application                              |
| 1    | Very Low, Min 3W     | 4        | Lighting, Phone Charger, Radio              |
| 2    | Low, Min 50W         | 4        | + Television, Fan                           |
| 3    | Medium, Min 200W     | 8        | + Pumps, Refrigeration, Rice Cooker         |
| 4    | High, Min 800W       | 16       | + Washing Machine, Iron, Toaster, Microwave |
| 5    | Very High, Min 2000W | 23       | + AC, Vacuum Cleaner                        |

Table 1: SE4ALL Multi-tier Framework

| SUMMARY OF LOAD PROFILE    |             |
|----------------------------|-------------|
| mean daily consumption     | 300 kWh/d   |
| mean monthly consumption   | 9.1 MWh/m   |
| annual consumption         | 109.5 MWh/y |
| maximal power              | 55.7 kW     |
| starting time of peak load | 18:00:00    |

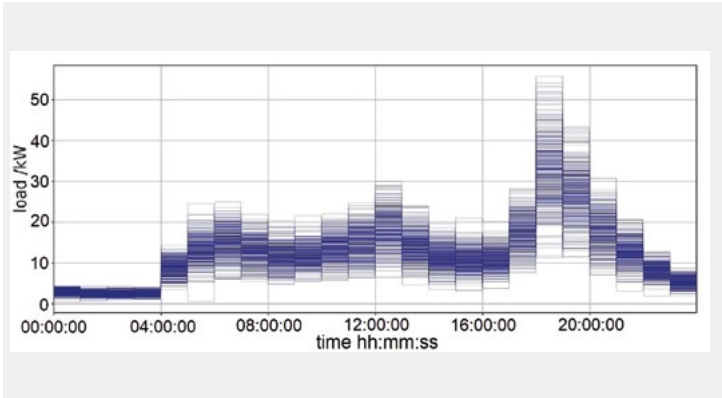

Figure 22: Maximal, minimal and median power demand

| LOAD PER HOUSEHOLD     |            |
|------------------------|------------|
| number of households   | 67         |
| maximal power          | 0.83 kW    |
| mean daily consumption | 4.48 kWh/d |
| number of households   | 43         |
| maximal power          | 1.30 kW    |
| mean daily consumption | 6.98 kWh/d |

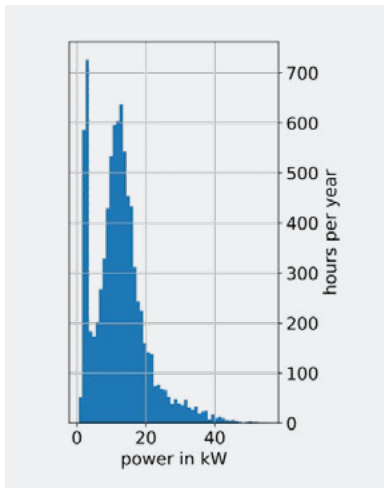
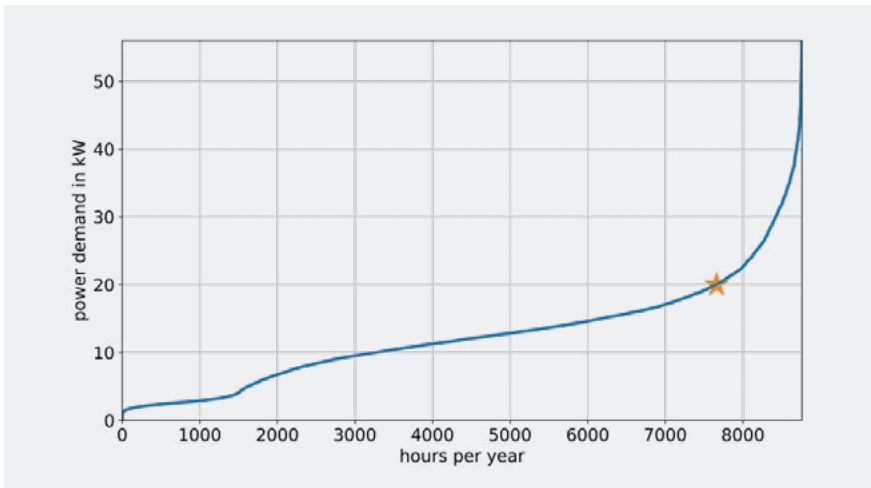

Figure 23: Annual consumption curve and power demand histogram

## System Design

In the first part of the project the generation is provided only from a hybrid PV system. In the second part of the project the possibilities of integrating a wind generation system are studied and analysed. In order to avoid electricity being used for cooking, gas stoves and cylinders were provided to the community to prevent inefficient electrical consumption.

The final design of the first phase consists of 75 kW<sub>peak</sub> PV power with around 130 kWh battery storage on the DC side. An additional 40 kW diesel generator for backup and times of high peak demand supports the grid on the AC side. Three converters of 20 kW each will be used to form the grid and enable battery charging with the diesel generator. All converters are supposed to be able to work as inverter and rectifier. The grid will be formed by one of the inverters.

The hybrid minigrid schematic and components are shown in figure a. Figure b is a single diagram of the system with AC-coupled components. The three-phase AC-coupled system will feed individual houses with three arrays of single-phase connections.

| COMPONENT                | CAPACITY           |
|--------------------------|--------------------|
| PV                       | 75 kW peak         |
| Diesel generator         | 40 kW              |
| PV inverter              | 60 kW (3*20 kW)    |
| Battery inverter         | 6-9 kW             |
| Storage (Li-Ion battery) | 130 kWh (2*65 kWh) |

Table 2: minigrid components

Smart meters are installed in all households. They are able to monitor consumption and detect fraud. The second important feature of smart meters in a vulnerable minigrid connection is the ability to reduce load and curtailments following a period frequency scheme. In cases where a group of households consumes more power than the system allows, that group can be automatically cut off from service for a short time. Through a load shedding schedule, the installation is protected to avoid full depletion of the batteries and unnecessary consumption of fuel for the diesel generator.

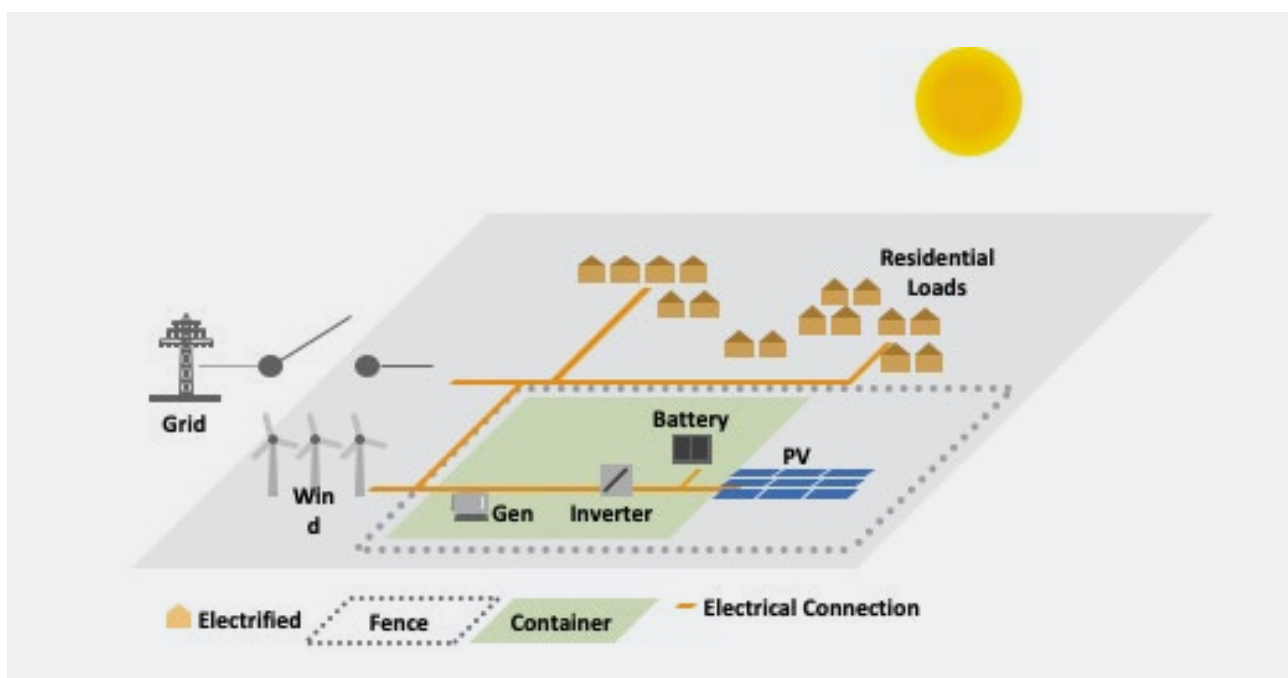

Figure 24: Project schematic, components and connection

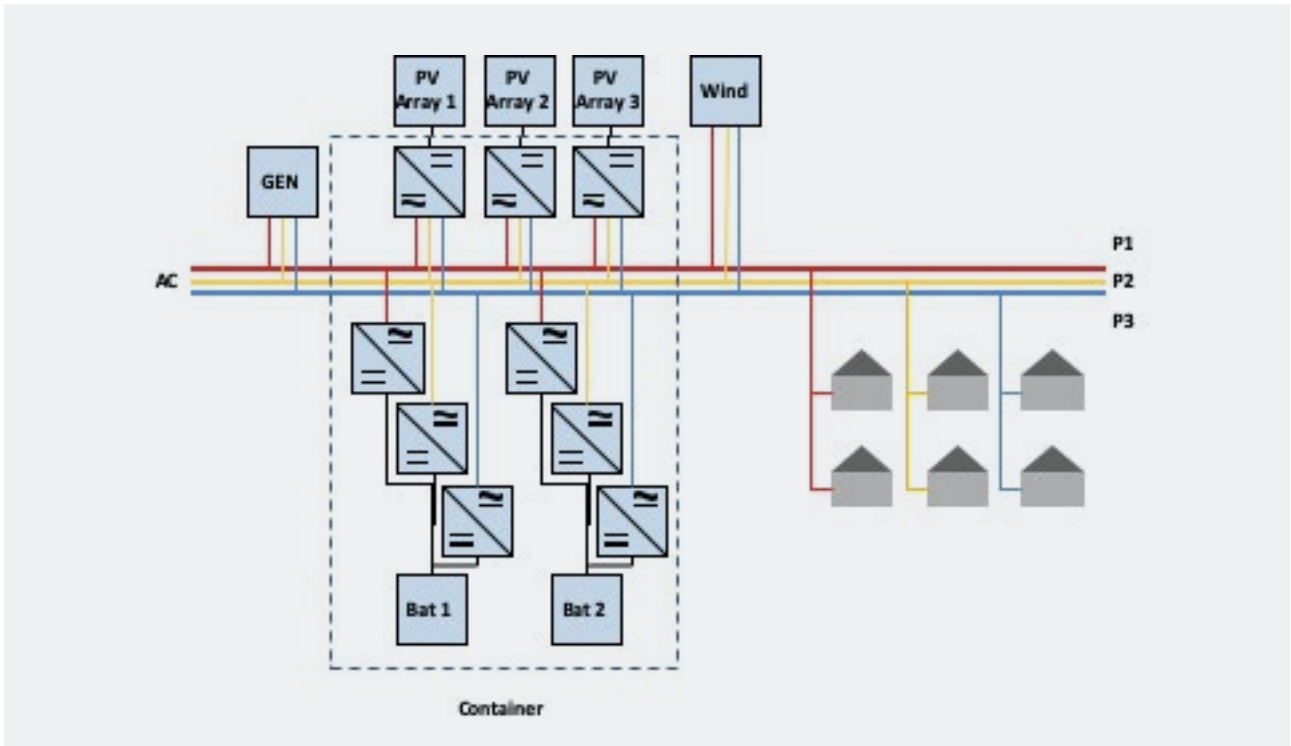

Figure 25: Minigrad single-line diagramm (the three phases are coloured as red, yellow, blue)

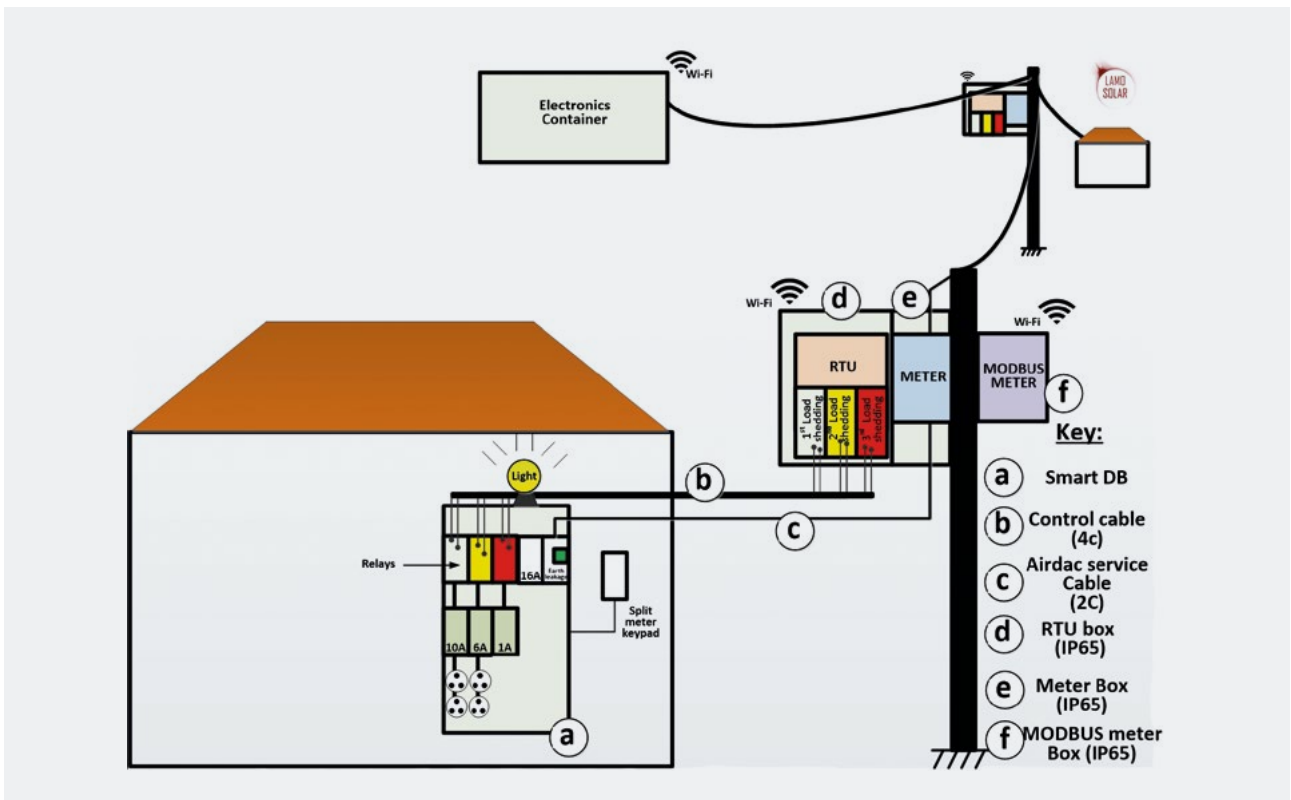

Figure 26: Overview of control system integration



## System Development

The system development followed an iterative process, with a number of stages in its implementation: first, a baseline needs assessment was carried out by the local municipality together with the DLR in the pilot villages, which served as the basis for the development of energy use scenarios and a first technical design in the beginning of 2017. The original technical generation design was adapted to financial and social restrictions and requirements that came up through discussions with partners in South Africa. Eyabantu Electrical Engineers, who were contracted by DEDEAT, designed the reticulation part and distribution from the hybrid generation point.

In a second step, after the technical design was agreed by all partners, the tender documents for the minigrad based on South African regulations needed to be drafted by an engineering firm. A South African engineering company, Africoast, was commissioned to prepare the technical specifications, which was the basis for the official tender in South Africa. The company also served as the owner's engineer during the construction of the minigrad.

A first tender went out to install the PV panels and fencing through the support of ECRDA. The local company Shared Energy Management installed and commissioned the PV panels.

After completion of the 1st tender, a 2nd tender was launched through the GIZ to fully construct the minigrad as an EPC contract (engineer, procure and



Figure 27: Ready board installed at the household (electricity outlets and payment system)



Figure 28: Connected household

construct type of contract). The contractor that won the tender was Lamo Solar in cooperation with Greenmax Energy, who were responsible for the following: detailed design of the grid, preparation of the site, procurement of the equipment, installation of the grid and testing and commissioning of the grid together with DEDEAT, the municipality and the owner's engineer.

Furthermore, a facilitator was hired by DEDEAT to interact with the local population.

In view of the sharp increase in the cost of the systems compared to the original planning, it was agreed at the workshops that the funds made available from the BLP project would be used for the preparation of detailed technical specifications by a local engineering office and for the procurement and installation of the PV systems and other technologies for energy production.



Figure 29: Distribution line connecting two sides of the village



Figure 30: Minigrid fenced area

A project plan was first developed by GIZ and DEDEAT but needed to be continuously adapted due to unforeseen changes in the project implementation. Thus the project implementation was kept flexible to adjust to all relevant needs for changes. Adjustments in the project plan needed to be made, for some activities such as the development of the technical specifications were delayed, as well as the tender process and the contracting. For the construction of the minigrid a project plan was developed by the contractor Lamo Solar and adapted in the implementation stage, as the procurement and installation of the equipment suffered from delays as well.

The main contracts for the partners in Lower Saxony and the tender for the procurement and construction of the minigrid as well as the monitoring of the grid were managed by GIZ. The contractor Lamo Solar was selected through an open tender in South Africa based on a technical and financial evaluation.

### Wind Component Design

As the occurrence of load shedding and excess energy are big challenges of minigrids this problem needed to be faced by the project as well. A sustainable solution to reduce the variability of power without reverting to fossil fuel backups needed to be found. The CSIR therefore conducted an optimisation study to identify the best possible dispatch strategy which minimizes the named problems by optimising the generation production by adding a wind power component to

the system. To further reduce the excess energy in the minigrid, an investigation into adding more battery storage was undertaken by the CSIR. This investigation has shown that the cost of purchasing the battery storage far outweighs the benefits of fuel savings. The investigation results stated that with this strategy, of adding a wind component and battery storage, a greater consistency of power can be assured and consequently a lot of fuel, and hence money, can be saved.

Timelines were pushed, as the wind component joined the project when it had already progressed into a developmental stage. As a result, all feasibility analyses were forced into a shorter than usual timeframe. The approach applicable was thus governed heavily by this reduced timeframe.

The project members focused on wind analysis and were responsible for the wind assessment and the environmental and social impact assessments.

The approach taken to conduct an accurate wind assessment within the limited allowable timeframe involved a six-month measurement campaign and utilization of the measure-correlate-predict (MCP) method to expand the dataset to a required full year. Firstly, the Lidar (wind measurement device) had to be positioned on site. This was predetermined by using WASA data (modelled data) of the area to map the power density. The area's power density potential and the proximity to the proposed power station were evaluated, and the Lidar was positioned in the preliminary turbine siting location based on proximity to the localized power station and the area's power densities readings. With a completed six-month measurement



Figure 31: Distribution line



Figure 32: Minigrid system container

campaign, the dataset was expanded using the MCP method to a full year. The dataset was deployed in WASP © to model a proposed wind development using a modelled map (imitating onsite roughness barriers), climate analysis and a modelled turbine. A feasibility analysis matrix comparing different aspects of the development was developed to help select the best solution. With the results obtained from the modelled projection and the feasibility analysis matrix, the site, size and specs of the turbines were determined.

The project team was also responsible for ensuring community acceptance and that all of the environmental regulations were met. The approach taken to meet these requirements was to educate the community on the proposed developments and to consult environmental experts on the proposed developments. The community was well informed in two separate meeting engagements, where each step was thoroughly explained, as were the purpose of each device and the progress of the project. The environmental experts confirmed that an environmental impact assessment was not required due to the scale of the project and that the project team required approval only from the Civil Aviation Authority, which was obtained.

## Costing Model

Instead of developing a costing spreadsheet from scratch, the UNDP Derisking Renewable Energy Investment (DREI) minigrid LCOE Tool was modified. The spreadsheet had been developed in 2018 as part of the UNDP “De-risking Renewable Energy Investment” programme.

The tool as written calculates the levelized cost of electricity (LCOE) for solar PV-battery minigrids, before and after the introduction of public instruments. The financial tool is organized into 13 worksheets: 1) Summary Output, 2) Inputs Load Profile, 3) Inputs Baseline Diesel, 4) Inputs Solar PV Battery, 5) Load Profile, 6) Generation, 7) LCOE Diesel, 8) LCOE Solar, 9) Irradiation Data, 10) Instrument Costing, 11) Sensitivity Outputs, 12) Charts, and 13) Report Summary Table.

At the very least, the existing spreadsheet needed to be populated with user-entered data reflecting the minigrid at hand: generation specifics (diesel, solar and battery capacities and characteristics), and load specifics (number, rating, and daily beginning and end times of individual electrical appliance loads in households, schools and other entities). In addition, the local solar resource must be specified for the PV array: global horizontal irradiation (GHI) and ambient temperature data, in 8760 hourly increments for a full year.





Figure 33: Minigrid PV (photovoltaic) system

In addition to this minimum, a capability for wind power generation needed to be added. This gave rise to a challenge: the generation of wind and solar electricity are correlated in day-time: weather events impact both PV power (for example, through cloud cover) and wind power. The use of typical meteorological year (TMY) data is typical for solar power calculations. Adding a different TMY for the wind data assumes that wind and solar power are uncorrelated. What is required is typical production for the combined solar and wind installation.

To address the two complications above, the Renewables.ninja software modelling tool was used to model the performance of the wind and PV portions for the actual site for actual historical years.

Further to the above is the fact that the theoretical basis for the PV power calculation as applied in the DREI spreadsheet was incorrect and needed to be rewritten.

Finally, the generator and battery dispatch strategy embedded within the DREI spreadsheet is quite sophisticated and differs from the dispatch strategy adopted by the HOMER modelling team. This disparity is currently being addressed and will be available upon completion.

## Operation & Maintenance

The O&M phase is part of the contract of Lamo Solar and will be implemented by Lamo Solar for 18 months. In this time, the municipality shall receive technical training in the operation and management of the system. The O&M contract secures the sustainability of the minigrid after the handing over of the system.

## 2.3. Monitoring & Evaluation

The successful implementation of minigrids requires the right set of technologies, access to financing, a consumer-friendly payment system, an appropriate regulatory environment, social facilitation, institutional implementation, an environmental impact evaluation, human capitalization and training, and implementing a robust, reliable, and sustainable Monitoring and Evaluation Framework (MEF).

With limited experience in developing and operating minigrids in South Africa, there is little practical data available to scale-up or transfer the technology to other regions. A number of challenges have been experienced in the course of implementing minigrids, including:

- ▶ Operational challenges due to the remoteness of the site and the complexity of these systems
- ▶ Ensuring that the system is functioning according to the initial design specifications
- ▶ Integration of smart technologies to support and maintain sustainable data flow including transfer and storage
- ▶ Data interface and reporting to various stakeholders
- ▶ Live monitoring and support due to unreliable cellular network

As a first-of-its-kind service delivery approach in the South African context it is important to evaluate not only the technical success, but also the social, economic and institutional impacts of the technological implementation. With this background the following goals were envisioned for this pilot project:

- ▶ Monitor the electricity generation and track the evolution of household consumption from having no access to energy to a reliable grid-quality electricity service
- ▶ Study and analyse the socio-economic impact on the community as a whole after gaining electricity access

A sustainable MEF can bridge the gap between the design and operation in the long run. It can eventually guarantee the flow of essential data to various stakeholders, including governmental organizations, utility operators, consumers, research institutes, investors, universities, and local authorities to manage, evaluate and optimize the system.

## Key Performance Indicators

*“Constantly monitoring the minigrid via a remote monitoring system helped with detecting any to all issues incl. connectivity, faults, under performance, etc.”*

(participant’s reflection)

In order to monitor, evaluate and optimize the minigrid, a set of Key Performance Indicators (KPIs) has been developed through a technical workshop with all the stakeholders, including local universities, the municipality of Upper Blinkwater and other strategic and executive partners mentioned in the Acknowledgements section.

In the first step, the main features of the MEF and the integrated components are specified. Two types of data sources, energy (i.e. generation, consumption,

storage, power quality, etc.) and non-energy (i.e. revenues from prepaid electricity meters), are defined as the base to parameterize the minigrid system.

In the next phase KPIs are categorized into five domains, including: technical, operational, financial, social, and environmental according to the specific needs of each stakeholder.

The sustainable flow of data measured and collected from the minigrid will not only support the decision makers and operators in monitoring and evaluating the system; the KPIs will also be used as a basis to generate a comprehensive report for each stakeholder based on their specific demand and requirement.

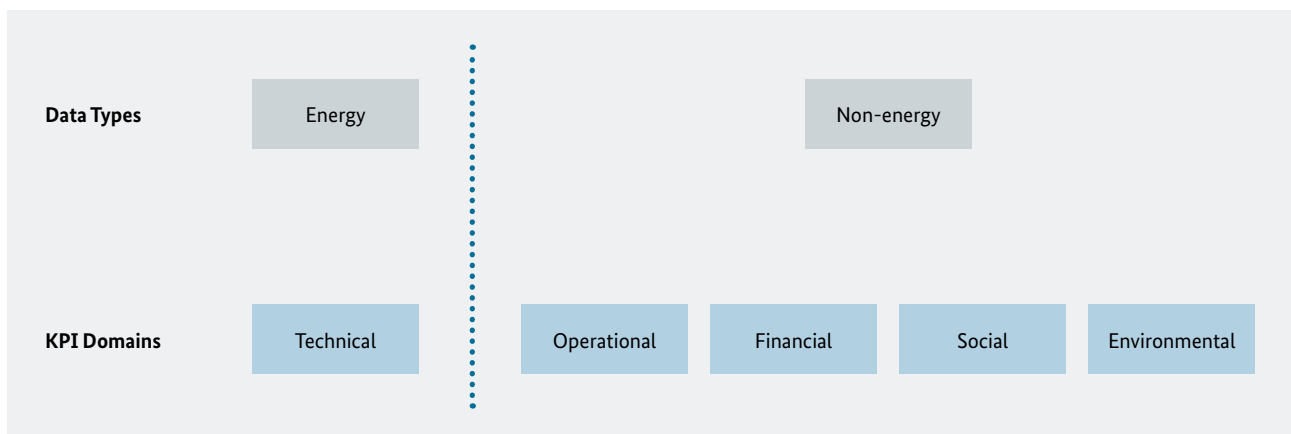

Figure 34: KPI data types and domains

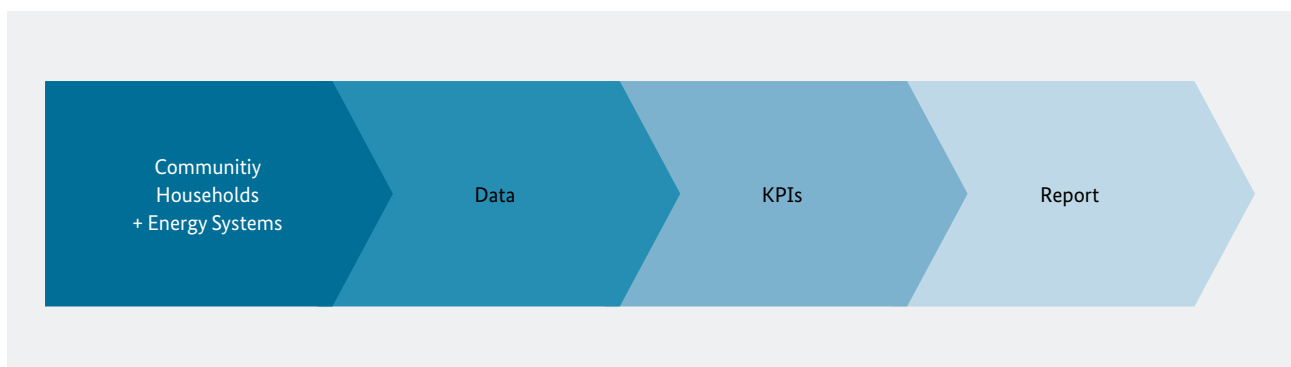

Figure 35: Flow of data from the minigrid to the comprehensive report

## Data Acquisition and Management

With the advancement of smart grid technologies, it is becoming easier to monitor and track the production of each component of hybrid systems. Beyond generation technologies, innovations in enabling components, including smart control systems that take advantage of the internet of things, have created opportunities to better integrate large shares of solar and wind in isolated power systems. Cloud-based monitoring solutions for minigrids integrate the communications hardware in meters and transmit consumption data to a central gateway. These applications reduce electricity cost and increase the reliability of electricity supply by optimizing consumption, thus reducing generation and storage (e.g. battery size) costs [12]. Integrating a smart energy management is also critical to ensuring stability and quality of supply. Smart energy management enables real-time and cost-effective monitoring and management of all the assets on a minigrid, thus improving resource efficiency.

The following features have been considered as the base requirements for the MEF system:

- ▶ Data collection (economic, automatic, accuracy, resolution, compatibility)
- ▶ Data transfer and storage (economic, reliable, automatic, wireless)
- ▶ Ease of access to data (internet-based)
- ▶ Security of data (secure servers, authenticated)
- ▶ Scalability (envisioning the growing demand and community size)

Based on the selected KPIs and the overall project requirements, a data flow scheme is designed and the appropriate metering and telecommunication technologies, software modules, and data interfaces are integrated.

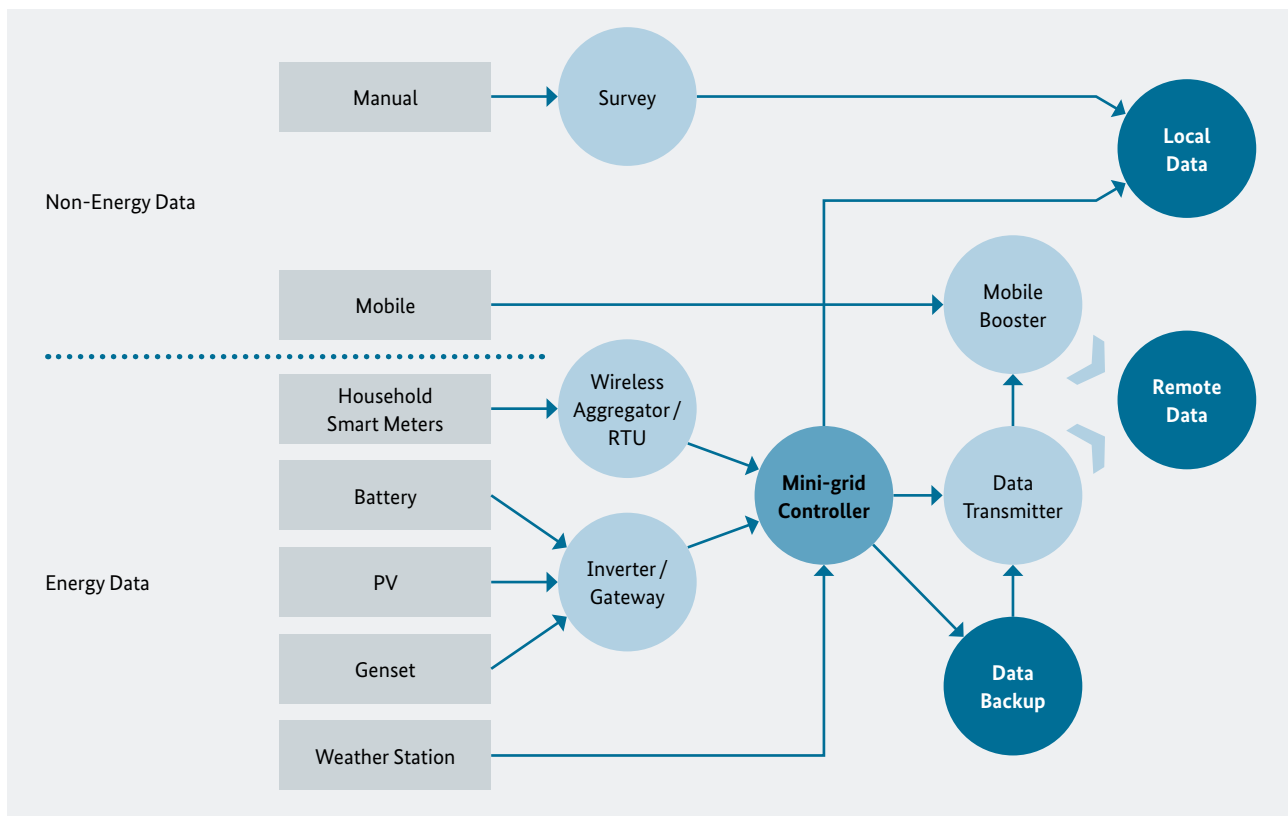

Figure 36: Minigrid Monitoring & Evaluation Framework (data acquisition components)



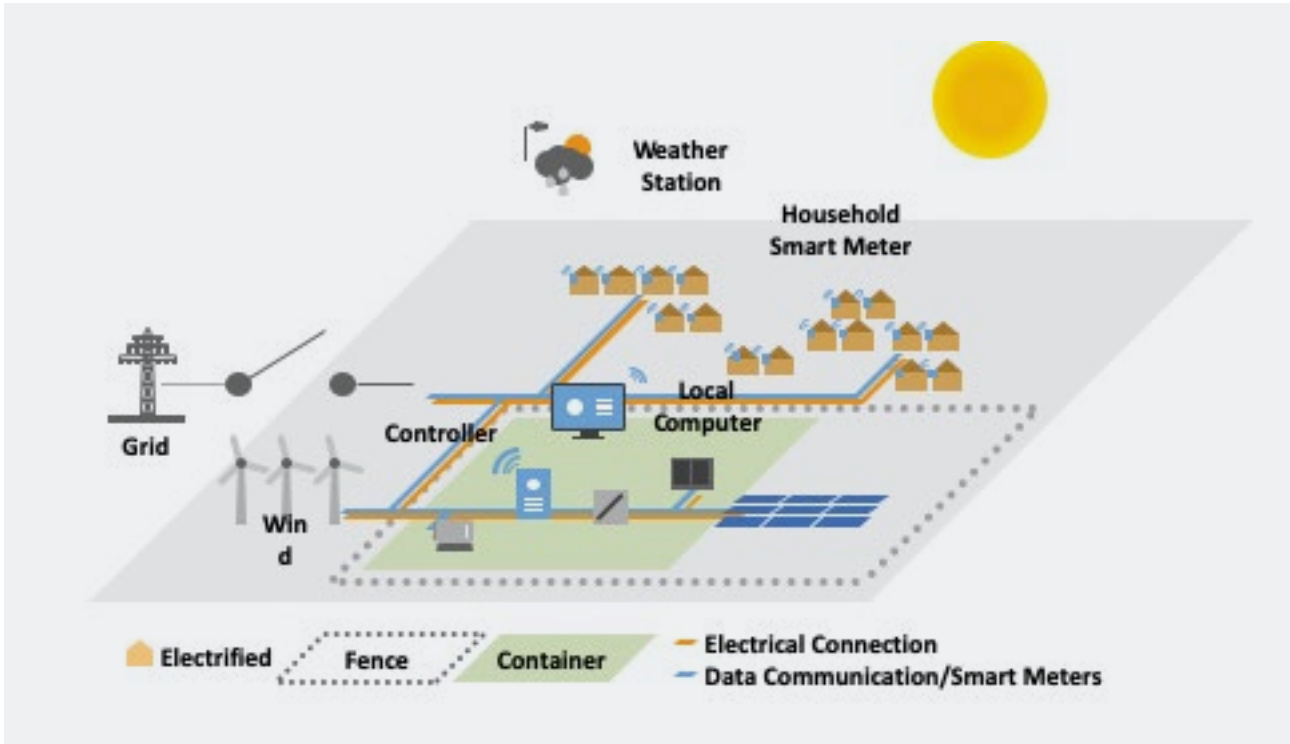

Figure 37: Project schematic, components and connection

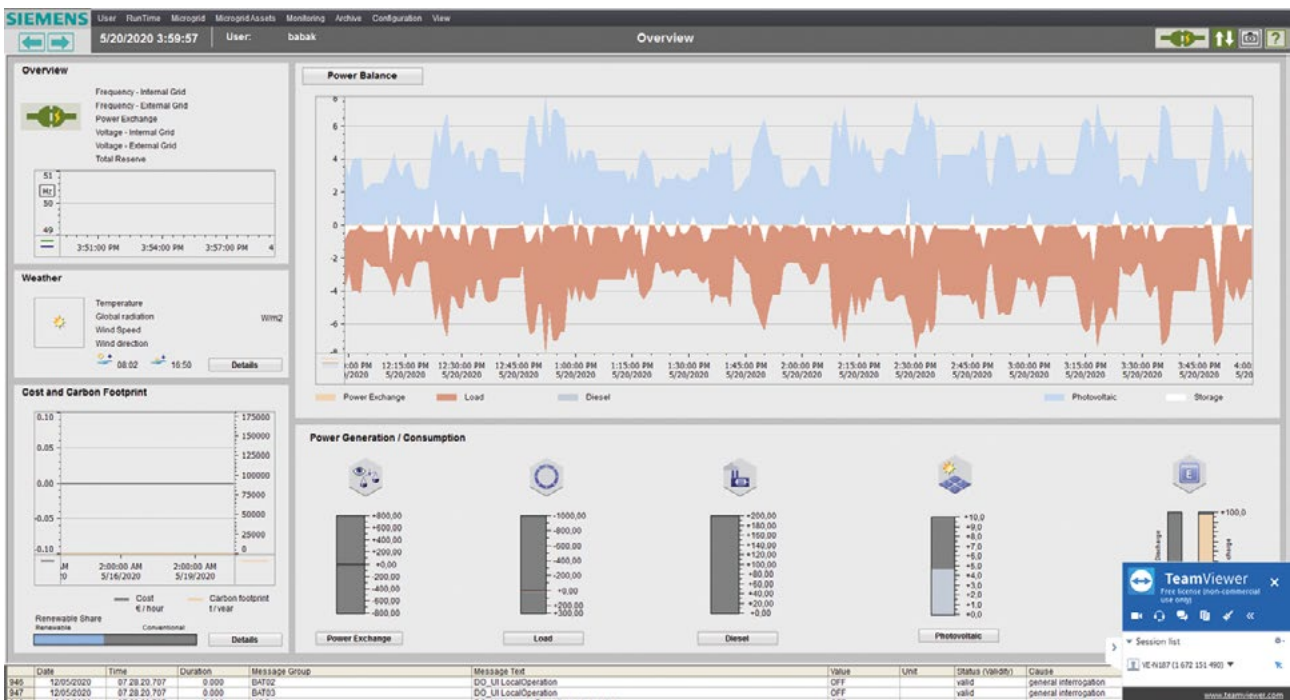

Figure 38: Minigrad Monitoring & Evaluation Data Dashboard – Display of the Siemens Mini-grid Controller Dashboard

The system consists of smart metering devices measuring real-time data from every component in the system, including household smart meters, generation and storage meters, and a state-of-the-art weather station. The measured data is collected and fed to the minigrid controller. The minigrid controller is set up to automatically push the data to a cloud-based portal.

In addition to data acquisition for monitoring, the system is integrated with control and diagnostic features. The minigrid controller unit is programmed to control the load flow and trigger load shedding according to a set of pre-defined and adjustable load level scenarios. The minigrid controller communicates with the inverters, battery and the generator to adjust the feed-in from the renewable generation to the demand. The minigrid MEF also provides critical and timely data to the operator for diagnostic and operational purposes.



Figure 39: Minigrid on-site weather station



Figure 40: Minigrid weather station dashboard – Display of the DAVIS Weather Link Dashboard

## Smart DB

- ▶ 56 Conlog prepaid meters are installed on the poles adjacent to the houses
- ▶ 70 ready boards were supplied by Allbro manufacturers with CoC
- ▶ 56 smart DBs were installed
- ▶ The ready boards were made smart by integrating automatic relays which perform load shedding
- ▶ The main controller and EMS communicate together frequently using wired MODBUS communication in order to exchange battery SOC values faster should the controller request this at any point.
- ▶ RTU and smart DB only receive information and hence do not require any memory intelligence apart from automatic relays.
- ▶ RTUs receive commands from the main controller via a WLAN network.
- ▶ RTUs will be strategically placed in cluster boxes in order to minimize the WLAN network
- ▶ RTUs will control relays located inside each house via wired communication

Upon receiving a load shedding command, the main controller sends information to specific RTUs assigned for any of the following three stages:

- ▶ 1st Load Shedding – When battery SOC goes below 75 %
- ▶ 2nd Load Shedding – When SOC drops below 50 %
- ▶ 3rd Load Shedding – When SOC drops below 25 %
- ▶ 4th Load Shedding – When no credits in Conlog meter

## Data-driven Household and Community Load Profiles

Minigrids provide energy services tailored and optimized for an estimated consumer load profile. For renewable hybrid minigrids, the fluctuating nature of resources adds more complexity to the challenge of maintaining the energy balance. Therefore, having access to accurate load profiles is indispensable for the initial design and optimization during the operation.

Standard urban household load profiles are useful and essential in the field of energy research, and there has already been significant scientific contribution to this subject. In contrast, there have been relatively fewer efforts to address rural load profiles connected to renewable hybrid minigrids, especially for rural communities with no access to electricity after gaining a reliable grid-quality service, as the load profiles would evolve over time.

In the preliminary design phase of the project the individual household demand is characterized and estimated according to the standard pre-defined set of load profiles obtained from World Bank MTF, and consequently the minigrid generation and storage capacity is modelled and calculated based on these standard estimated sets

of load profiles. The MEF provides the opportunity to streamline the flow of real-time energy data (generation, consumption, and storage) from the system to generate accurate and high-resolution data-driven load profiles for rural households or communities. These profiles are used for studying and analysing the evolution of demand and making ongoing design optimization. They will be useful as a reference for minigrid researchers and developers active in Sub-Saharan Africa.

Joint monitoring of the institutional integration promotes the development of regulatory frameworks for so-called minigrids and decentralized electricity supply scenarios. The rural minigrid will be used as a “living lab” by South African universities and research facilities to study the development and evolution of energy demand and the desired feedback on local prosperity [10].

# Impact



### 3.1. Working Together

*“Despite the remote nature of the project for both sides, regular online communication (bi-weekly Skype) and emails kept the project on track”*

(participant’s reflection)

The project implementation benefited from the strong partnership and will for cooperation. There was an excellent collaboration and close coordination of the main project partners in Germany and South Africa. Key coordination was pushed strongly by Lower Saxony in the beginning, which established the positive spirit that the project is still benefiting from up to the present.

Even though not formally agreed, a good management structure was set up by DEDEAT dividing technical and financial issues activities in the Eastern Cape, as well as a clear separation of roles and responsibilities within the project.

The facilitation process set up in the pilot village guaranteed the continuous involvement and information of the community, which was very important for the project implementation. The sustainability of the minigrid is secured through ownership of the municipality. For the communication within the project team, the initial workshops in Germany and South Africa provided a good basis to bring all partners together and share ideas and results.

## 3.2. Community Engagement

*“Social facilitation was just too good, starting from sharing of information through meetings, workshops & research activities. We felt that we were part of the project.”*

(participant’s reflection)

Bringing electricity to a community in an isolated area requires social acceptance from the entire community to guarantee the sustainability of the project. Open communication and transparency were key from the very start of the project, with everyone from that community involved. From conception until commissioning, every step was clearly explained, with room for questions and comments to ensure full transparency and avoid any misunderstanding. In a South African context, energy access is a right to all South Africans, which makes the topic of energy access a sensitive one.

A structure was created to formalize the communication stream to consider everyone’s interests and allow a platform to raise issues or challenges from different perspectives. A Community Project Steering Committee was set up as the main social body that represented the community of Upper Blinkwater during the construction of the minigrid. This CPSC was organ-

ized with the presence of the community leaders, the community liaison officer, the social facilitator and the ward councillor, where every member of the CPSC represented an important stakeholder.

The community leaders were directly elected by the community and represented the community as such. This process of electing the leaders took place before the project was introduced to the community, which made the introduction of the project much easier.

The community liaison officer, CLO, was chosen through a local job posting process, as certain skills and conditions were required to fulfil this position. The position was paid through the construction contractor, where this person represented the community members selected for local labour, who were also on the payroll of the contractor. This role was crucial to allow smooth communication and cooperation between the contractor, local labour workers and the community.

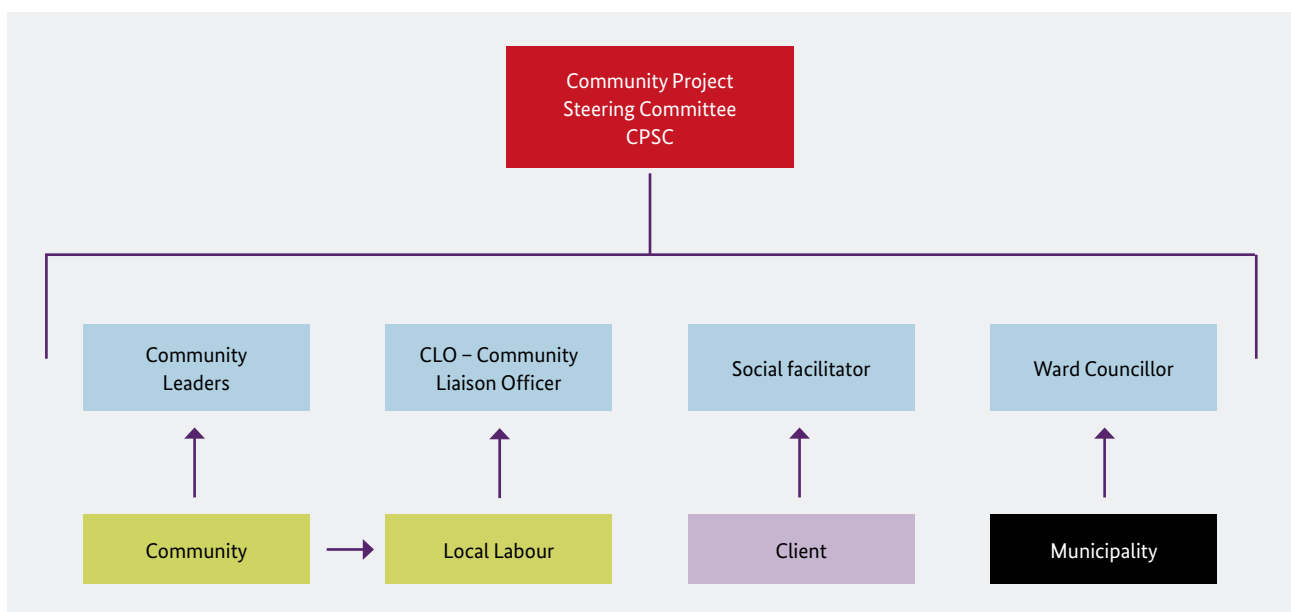

Figure 41: Structure of the Community Project Steering Committee – CPSC





Figure 42: Community Project Steering Committee in action during meeting on site, chaired by the councillor (left) and social facilitator (right), with the minigrid in the background

The social facilitator was engaged through the client, in this case DEDEAT, whose role was to make sure that the client's interests were represented, and to facilitate every social challenge with a direct contact to the client if further support or assistance is needed. As mentioned before, the social facilitator played, and continues to play, a key role in the whole project, which has contributed to the overall success of the project.

The ward councillor, who was appointed through the municipality, was the direct representative of the municipality, and brought in the political sphere of cooperation and implementation with the municipality itself.

Through the structure implemented, the community was engaged and fully aware of what was happening on site at every moment and what was planned in the near future. As different stakeholders and partners were involved, site visits were organized regularly, and these were communicated through the CPSC to allow acceptance of different partners on site and avoid misunderstanding.

The CPSC was successful, as certain issues were raised during the timeline of the project, such as local labour contracts and requirements, land ownership, job posting, material handling and many more. Each of these issues were handled following the implemented structure and brought a solution that was unanimously approved by the community.



### 3.3. Clean Energy & Social Development

By definition, social development is about improving the economic status and wellbeing of especially the socially or economically disadvantaged [14]. It encompasses a variety of social aspects, including population, gender aspects, education, employment, income, housing and access to basic services such as health facilities and access to energy [15]. Regardless of its source, energy is the driving force for development. Energy facilitates all facets of social and economic activities. It is therefore deemed critical for improving quality of life and eradicating poverty.

Once a community has access to electricity, it can also have access to safe potable water, better health conditions, food security, as well as lighting and information. Women are the key beneficiaries of the availability of and access to energy [17]. Having access to electricity not only enables them to use appliances for cooking, lighting etc., but emancipates and empowers them, as it will release them from the long hours of household work and fuel collection and enable them to engage in income-generating activities within the home and community [16].

The aim of the social study with UFH is to evaluate the social and economic impacts of the hybrid minigrid system in the Upper Blinkwater project. To achieve this, the baseline information was established. This is the survey documenting the current and existing state of the community to provide a picture of the status quo, from which changes in the livelihood and wellbeing of the community/household recipients resulting from the implementation of the minigrid can be measured. Likewise, the question of how much energy is required and who the end-user of the energy generated is, is central to “load profiling and determination of energy usage patterns”. Therefore, thorough information on the probable number of households connecting to the minigrid is essential.

The results would be used to indicate if the project yielded the desired effects on the community, and, most specifically, will clarify how and to what extent access to electricity and such infrastructure contribute to economic and social development.

#### Impact Assessment Plan

As enclosed in the National Development Plan, meeting the people’s most immediate needs such as jobs, land, housing, water, electricity, telecommunications, transport, a clean and healthy environment, health care and social welfare, and shaping the future of the previously excluded communities [18] is a priority for South Africa. The scope of the community profiling was therefore designed according to those socio-economic indices and aspects most likely to be affected by the minigrid. The focus is on general household/com-

| SOCIAL SURVEY FOCUS AREAS   |
|---|
| Household roster and personal characteristics   |
| Education   |
| Employment status   |
| Social security   |
| General household information and service delivery <ul style="list-style-type: none"> <li>▶ Housing</li> <li>▶ Water</li> <li>▶ Sanitation and hygiene</li> <li>▶ Energy</li> </ul> |
| Communication and transport   |
| Health, welfare and food security   |
| Household livelihoods <ul style="list-style-type: none"> <li>▶ Agricultural activities</li> <li>▶ Household income sources and expenditures</li> <li>▶ Leisure</li> </ul>           |
| Social cohesion   |

Table 3: Social Survey Focus Areas

munity conditions associated with the socio-economic development. The key parameters are presented in the following table.

Prior to the implementation of the project, community profiling was undertaken, and the scope included the factors most likely to be affected by project, as indicated in the table. At this point in time, our understanding that rural electrification has a number of benefits to offer to this rural community is based on the literature, but what exactly those changes are and what the direction of the change would be as well as the success of the project are unknown. Following the analysis of the baseline information, a continuous assessment of the key indicators would be done at least every six months after the implementation of the minigrid in three years and every year thereafter.

The intent of this electrification project is not only to provide access to electricity, but also to improve the impoverished lives in this community and empower women. Undoubtedly, electricity alone may not be enough to create all the conditions for socio-economic conditions. There is a need to empower the community to raise their standard of living. The following are the short- and long-term aspirations of the community:

- ▶ The connection of the community of Upper Blinkwater to piped water
- ▶ The establishment of community-based projects and community groups
- ▶ The promotion of home vegetable gardens and communal agricultural projects
- ▶ The establishment of small-home/ community-based enterprises

As per the policy framework, the Reconstruction and Development Programme, the community of Upper Blinkwater has suffered the “second round of exclusion”. The community lacks:

- ▶ Better housing: mud houses are in a very bad condition with poor sheet roofing
- ▶ Access to clean water: water is from the streams, tanks and springs from the mountain
- ▶ Healthcare centre: no clinic at all – the nearest clinic is in Fort Beaufort, about 13.3 km from the village
- ▶ Road infrastructure: the road is poor and slippery in rainy seasons
- ▶ Schools: the school is not operational

Generally, the goal of rural electrification is sustainable development. This can be achieved only if energy strategies address the social issues and also pay a great deal of attention to different energy needs of women and men. Such strategies must focus on rectifying and improving the position of women in the home and the society.

# Joint Publications



## Joint Publications

An important aspect of the minigrid project as a pilot is to develop knowledge through research and engagement with local institutes and create channels to promote and transfer the knowledge and experience gained to a broader audience. The scientific publications aim at providing an insight for the developers, government, universities and other local partners for current and future similar projects. From the beginning we set the goal of engaging German and South African partners to achieve a common purpose in research by means of joint publications. We believe that joint research activities create long-term cooperation and commitment to the project, impacting the project outcome.

In addition to continuous simultaneous research work on both sides of the planet, an internship opportunity was arranged for a South African PhD student to travel to Germany and collaborate with the German partners at the DLR Networked Energy Systems institute in Germany. This created the opportunity for German and South African researchers to work together in a more efficient hands-on atmosphere, which resulted in developing concepts around the rural household load profiles, grid mapping, and minigrid electricity price estimation.

One of the main goals of our pilot project is to develop knowledge around the interrelation between electrification and social development. An extensive social survey that focuses both on the community and individual household levels is being carried out, and the ongoing analysis in the coming years will explore the social impact and its relation to the evolution of electricity consumption in the community.

A total of eight joint research publications were developed and accepted at both South African and international conferences and journals throughout the project.

- ▶ Africa-Oldenburg: Academic Encounters, Pathways, Perspectives
- ▶ EUPVSEC 2018
- ▶ 8th Solar Integration Workshop 2018
- ▶ EUPVSEC 2019
- ▶ SASEC 2019 - 6th Southern African Solar Energy Conference
- ▶ IET Renewable Power Generation
- ▶ 3rd International Conference on Solar Technologies & Hybrid Minigrids to improve energy access
- ▶ 15th International Conference on Ecological Vehicles and Renewable Energies (EVER) 2020

# Lessons Learned



## Lessons Learned

At the end of the project, especially due to its pilot character, the following crucial question was asked: What lessons were learned?

Lessons learned look at successes and failings, trace causes and effects as well as strengths and weaknesses and provide recommendations for improvements and a brief overview on “Good Practices”. A questionnaire addressing these questions was designed and handed to project partners. Furthermore, a workshop was held at the end of the project with the participation of many stakeholders from various institutes that were involved in the project. In this workshop,

many aspects of the project, from design via technical questions and monitoring to economic and social and environmental aspects, were addressed. Questions that directed the attention of the participants towards a common goal were raised, providing the opportunity to reflect, learn and share.

- ▶ As an outcome of the questionnaire and the workshop, the collective experiences of partners were gathered and documented in three main categories: Technical, Economic and Social & Environmental.

| TECHNICAL  | ECONOMIC   | SOCIAL & ENVIRONMENTAL   |
|--|--|--|
| <ul style="list-style-type: none"> <li>▶ Did the system size meet the expected service level expectations / requirements?</li> <li>▶ Was there capacity to source, install and manage the system?</li> <li>▶ What are the lessons in relation to understanding, monitoring and managing the system?</li> </ul> | <ul style="list-style-type: none"> <li>▶ What business model did the project develop to construct, own and manage the minigrid?</li> <li>▶ Was the project viable and risk managed effectively – can we start developing a LCOE for the project?</li> <li>▶ Is the project sustainable – management, flows of money, maintenance?</li> </ul> | <ul style="list-style-type: none"> <li>▶ How was the community engaged and how did they understand the services coming to them?</li> <li>▶ What benefits emerged from the project?</li> <li>▶ What are the social, environmental and economic impacts of switching from using traditional fuels to modern clean energy?</li> <li>▶ Any evident changes in energy gender interaction within the household?</li> </ul> |

The following tables display the outcomes:

## Technical

|                              |  |
|------------------------------|--|
| <p><b>CHALLENGES</b></p>     | <ul style="list-style-type: none"> <li>➤ Finding a common understanding with different stakeholders</li> <li>➤ Different project components with different budgets spent over different times: how to build flexibility into project plans and budgets and contracts</li> <li>➤ Getting sign-off from municipality on time and upskilling on how to operate and manage the grid</li> <li>➤ People leaving the community/project, loss of knowledge</li> <li>➤ Remoteness of area, difficult to get internet, and for maintenance</li> <li>➤ Procurement: e.g. few options for minigrid suppliers, and few SA ones and also delays in deliveries</li> <li>➤ No running costs included in the EPC contract (diesel and internet)</li> <li>➤ Not respecting timelines</li> <li>➤ Integration of wind into project, not enough data</li> </ul> |
| <p><b>ACHIEVEMENTS</b></p>   | <ul style="list-style-type: none"> <li>➤ Happy community: successful installation of minigrid in a community, which has failed in a similar previous project (Lucingweni)</li> <li>➤ Demand-side management in a way that doesn't cause tensions</li> <li>➤ Back integration into municipality technical system</li> <li>➤ Attracting partnerships/engagements/recognition with other organizations – e.g. UNDP</li> </ul>   |
| <p><b>BEST PRACTICES</b></p> | <ul style="list-style-type: none"> <li>➤ Money and time for stakeholder process</li> <li>➤ Important to have a social facilitator that has both social and engineering capabilities</li> <li>➤ Important to have a campaign awareness in the community</li> <li>➤ To look at energy demand for all types of energy and not just electricity (e.g. strategy for cooking)</li> <li>➤ Optimization study before buying of components</li> </ul>   |

## Economic

|                       |  |
|-----------------------|--|
| <b>CHALLENGES</b>     | <ul style="list-style-type: none"> <li>➤ Need to understand if the municipality has the capacity to pay for operations and maintenance – and if not, how to build and develop this</li> <li>➤ Need to do the work to ensure productive use of energy</li> </ul>  |
| <b>ACHIEVEMENTS</b>   | <ul style="list-style-type: none"> <li>➤ Minigrid up and running and people purchasing electricity)</li> <li>➤ Understanding that community engagement is key</li> <li>➤ Keen and interested municipality</li> <li>➤ Institutional lead (DEDEAT) and time (18 months) really work on the policy</li> <li>➤ Institutional and productive use of energy – NOTING this phase is key</li> </ul>  |
| <b>BEST PRACTICES</b> | <ul style="list-style-type: none"> <li>➤ Costing/financial model developed from the start – CSIR work will help to develop this (how much cost and how much sell electricity for)</li> <li>➤ Policy work with Nersa/DMRE related to pricing for minigrids and where the capital/operational subsidies come from</li> <li>➤ Institutional exploration – there is a need to clarify the ongoing costs of the minigrid and where the sources of revenue/funding to cover this costs will come from; once costing is clear, the institution to manage the minigrid service must be established (i.e. on a viable financial basis). In South Africa the municipality so key – but they must not be set up for failure; how to make this viable?</li> <li>➤ Productive use of energy – starts to make the energy use an economic stimulus. What additional levers are required to make this happen?</li> </ul> |



## Social & Environmental

|                       |   |
|-----------------------|---|
| <b>CHALLENGES</b>     | <ul style="list-style-type: none"><li>➤ Monitoring &amp; Evaluation – social impacts</li><li>➤ Land ownership – land claimant</li><li>➤ Gas stoves – expectation for municipality/national government to refill the gas</li></ul>   |
| <b>ACHIEVEMENTS</b>   | <ul style="list-style-type: none"><li>➤ Community trust was strong</li><li>➤ Community awareness: at each stage the community understood what was happening and why</li><li>➤ Comprehension of electricity services</li><li>➤ Community ownership</li></ul>   |
| <b>BEST PRACTICES</b> | <ul style="list-style-type: none"><li>➤ Community engagement from early stage</li><li>➤ Consistency/Constant social facilitator with engineering qualifications</li><li>➤ Community ownership – responsibility of asset</li><li>➤ Technical, social, community forms of leadership have been included in the communication agenda</li><li>➤ Local employment – inclusion of women</li></ul> |

## References

- [1] United Nations, "The Sustainable Development Goals Report 2019," UN, New York, 2019.
- [2] World Bank, "Sustainable Energy for All (SE4ALL) database from the SE4ALL Global Tracking Framework led jointly by the World Bank, International Energy Agency, and the Energy Sector Management Assistance Program," Access to electricity (% of population), ID: EG.ELC.ACCS.ZS, 2019. [Online]. Available: <https://data.worldbank.org/indicator/EG.ELC.ACCS.ZS>. [Accessed 10 02 2020].
- [3] IEA, "'SDG7: Data and Projections", IEA, <https://www.iea.org/reports/sdg7-data-and-projections>," Paris, 2019.
- [4] G. Davies, "AFRICA IN FOCUS, Building the grid of the future, today," 2017. [Online]. Available: <https://www.brookings.edu/blog/africa-in-focus/2017/10/10/building-the-grid-of-the-future-today/>. [Accessed 10 10 2019].
- [5] IRENA, 'Off-grid renewable energy solutions: Global and regional status and trends', Abu Dhabi.: ISBN 978-92-9260-076-1, 2018.
- [6] S. C. Dubey and C. Morris, "World Bank Blogs," 2 October 2018. [Online]. Available: Sunita Chikatur Dubey, Catherine Morris, A new chapter for Sub-Saharan Africa's mini grids industry, OCTOBER 02, 2018, retrieved from <http://blogs.worldbank.org/nasikiliza/a-new-chapter-for-sub-saharan-africas-mini-grids-industry>. [Accessed 15 10 2019].
- [7] Department of Energy, Republic of South Africa, Integrated Resource Plan (IRP 2019), South Africa, October, 2019.
- [8] CSIR, Integrating off-grid solutions into South Africa's electrification programme, [http://www.cityenergy.org.za/uploads/resource\\_426.pdf](http://www.cityenergy.org.za/uploads/resource_426.pdf), May 2017.
- [9] Integrated Resource Plan (IRP2019), DEPARTMENT OF ENERGY, Number No. 1359, 18 OCTOBER 2019 [Online]. Available: [https://www.gov.za/sites/default/files/gcis\\_document/201910/42778gon1359.pdf](https://www.gov.za/sites/default/files/gcis_document/201910/42778gon1359.pdf). [Accessed 04 2020].
- [10] Kühnel, Hanke, Baranova, Weigel, Stuermer, McMaster, Maebe and v. Maydell, "Design of Hybrid-Minigrids in a South African Rural Areas under consideration of social and cultural Aspects," in EU PVSEC, 2018.
- [11] "Global Solar Atlas 2.0, a free, web-based application is developed and operated by the company Solargis s.r.o. on behalf of the World Bank Group, utilizing Solargis data, with funding provided by the Energy Sector Management Assistance Program (ESMAP).," [Online]. Available: <https://globalsolaratlas.info/map?r=ZAF&c=-28.671449,24.67085,6>.
- [12] IRENA, "Off-grid renewable energy solutions to expand electricity access: An opportunity not to be missed, International Renewable Energy Agency," Abu Dhab, 2019.
- [13] The World Bank, UN, "Accelerating sdg 7 achievement, policy brief 15, Tracking SDG 7.1 with the multi-tier framework, measuring energy access," Published by the United Nations, 2019.
- [14] M. BLUNK, Electricity and sustainable development: Impacts of solar home systems in rural bangladesh, Mainz, Germany: Department of Geography of the Johannes Gutenberg. University of Mainz., 2008.
- [15] United Nations (2005B), The Social Summit Ten Years Later, New York: United Nations, 2005.
- [16] United Nations, "Renewable energy technologies for rural development," in UNITED NATIONS CONFERENCE ON TRADE AND DEVELOPMENT UNCTAD, New York and Geneva, 2010.
- [17] S. S. Rathi and C. Vermaak, Rural Electrification, Gender And The Labor Market: A Cross-country Study Of India And South Africa, Vol. 109 ed., 2018, pp. 346-359.
- [18] P. O'Malley, The Reconstruction And Development Programme (RDP), The O'Malley Archives, 2017.

## Imprint

Published by:  
Deutsche Gesellschaft für Internationale Zusammenarbeit (GIZ) GmbH

Registered offices  
Bonn and Eschborn

Bund-Länder-Programm  
An der Alster 62  
20099 Hamburg Germany  
blp@giz.de

August 2020

Authors & Editing  
Jointly created work with text contribution from the partners involved  
Final editing by Linda Botha Language Solutions (Pty) Ltd (lbls), Pretoria, South Africa

Print  
Minuteman Press Int'l, Hatfield-Pretoria, South Africa  
Braun & Sohn Druckerei GmbH & Co. KG, Maintal, Germany

Design  
kipconcept gmbH, Bonn, Germany

Figure Credits  
DLR/ frontpage, p. 11, 21, 22, 25-28, 30-34, 36-42, 44-47, 65  
GIZ/p. 11, 52, 53  
IRENA/p. 22  
Global Solar Atlas/p. 23  
NMU/p. 25  
Google; CNES/Airbus, Maxar Technologies; AfriGIS/p. 25  
Lamo Solar/p. 38

The publication is distributed free of charge and is not intended for sale.  
GIZ is responsible for the content of this publication.  
As a federally owned enterprise, GIZ supports the German Government in achieving its objectives in the field of international cooperation for sustainable development.

On behalf of  
German Federal Ministry for Economic Cooperation and Development (BMZ)  
Referat Z33  
Länder, Kommunen

BMZ Bonn  
Dahlmannstraße 4  
53113 Bonn  
T +49(0)2289953350  
F +49(0)22899533500

BMZ Berlin | Im Europahaus  
Stresemannstraße 94  
10963 Berlin  
T +49(0)301853350  
F +49(0)30185352501

poststelle@bmz.bund.de  
www.bmz.de



