

Management and Destruction of Existing Ozone Depleting Substances Banks

Guideline on the Manual Dismantling
of Refrigerators and Air Conditioners



On behalf of:



Federal Ministry
for the Environment, Nature Conservation,
Building and Nuclear Safety

of the Federal Republic of Germany

Management and Destruction of Existing Ozone Depleting Substances Banks

Guideline on the Manual Dismantling
of Refrigerators and Air Conditioners



As a federally owned enterprise, GIZ supports the German Government in achieving its objectives in the field of international cooperation for sustainable development.

Published by

Deutsche Gesellschaft für
Internationale Zusammenarbeit (GIZ) GmbH

Registered offices

Bonn and Eschborn, Germany

Dag-Hammarskjöld-Weg 1-5

65760 Eschborn, Germany

Tel.: +49 6196 79-1022

Fax: +49 6196 79-80 1022

Email: proklima@giz.de

Internet: www.giz.de/proklima

Programme/project description

Management and Destruction of Existing Ozone Depleting Substances Banks/Proklima

Responsible

Bernhard Siegele, Proklima Programme Manager, bernhard.siegele@giz.de

Author

Dr Jonathan Heubes (HEAT GmbH, Königstein)

Review and collaboration

Nidia Mercedes Pabón Tello (Ministry of Environment and Sustainable Development, Colombia)

Jürgen Beckmann (Bavarian State Office for the Environment, Germany)

Cinthya Berrío, Johannes Frommann, Ellen Gunsilius, Franziska Frölich (GIZ GmbH, Eschborn)

Carolina Vélez (GIZ Colombia)

Proofreading

Gunther Weinell (textschriftmacher)

Nicole Müller (GIZ GmbH, Eschborn)

Silas Büse (GIZ GmbH, Eschborn)

Concept

Jürgen Usinger (HEAT GmbH, Königstein)

Layout

Jeanette Geppert (pixelundpunkt kommunikation, Frankfurt)

Photo

Title: Ministry of Environment and Sustainable Development of Colombia

Jürgen Beckmann, Georg Wallek, Ministry of Environment and Sustainable Development of Colombia, iStock (Figures 13, 16 and Step 4), Shutterstock (Figures 9, 12 and steps 25, 28), Jeanette Geppert (Figure 18 left, Figure 20)

URL links

This publication contains links to external websites. Responsibility for the content of the listed external sites always lies with their respective publishers. When the links to these sites were first posted, GIZ checked the third-party content to establish whether it could give rise to civil or criminal liability. However, the constant review of the links to external sites cannot reasonably be expected without concrete indication of a violation of rights. If GIZ itself becomes aware or is notified by a third party that an external site it has provided a link to gives rise to civil or criminal liability, it will remove the link to this site immediately. GIZ expressly dissociates itself from such content.

On behalf of the

German Federal Ministry for the Environment, Nature Conservation, Building and Nuclear Safety
Division KI II 7 International Climate Finance, International Climate Initiative
11055 Berlin, Germany
Tel.: +49 30 18 305-0
Fax: +49 30 18 305-4375
Email: KI117@bmub.bund.de
Internet: www.bmub.bund.de

GIZ is responsible for the content of this publication.

Printing and distribution

Aksoy Print & Projektmanagement

Printed on 100% recycled paper, certified to FSC standards.

Eschborn, 2017

Serial number

G-S01-2017-en-01

Credits

MINISTRY OF ENVIRONMENT AND SUSTAINABLE DEVELOPMENT OF THE REPUBLIC OF COLOMBIA

Luis Gilberto Murillo, Minister

Carlos Alberto Botero López, Deputy Minister

Willer Edilberto Guevara Hurtado, Director of Environmental Affairs (Sectoral and Urban)

Leydy María Suárez Orozco, National Coordinator of the Technical Ozone Unit – UTO

MANAGEMENT AND DESTRUCTION OF EXISTING OZONE DEPLETING SUBSTANCES BANKS

The Montreal Protocol on substances that deplete the ozone layer (ODS) has been effectively regulating the production and consumption of ODS since 1989. However, large banks of ODS have accumulated globally due to the excessive historical use of these substances. ODS are continuously being released to the atmosphere from these banks – damaging the ozone layer and contributing to global warming. It is important to note that these banks are not regulated under the Montreal Protocol. Adequate collection, recovery and destruction of ODS banks represent a challenge for developing countries.

Various programmes and projects that were promoted and financed by the Montreal Protocol, aiming at the reduction and elimination of ODS, resulted in the voluntary conversion to technologies free of these substances by large companies. This, together with import and trade controls of ODS, has ultimately contributed to an increase in waste stocks and equipment which contain ODS and now require final disposal.

The global project 'Management and Destruction of ODS Banks' supports the integrated waste management of ODS and equipment containing ODS. This project is commissioned by the Federal Ministry for the Environment, Nature Conservation, Building and Nuclear Safety (BMUB) as part of its International Climate Initiative (IKI) and being implemented by the Deutsche Gesellschaft für Internationale Zusammenarbeit (GIZ) GmbH. This guideline was developed as part of the ODS Banks project in close cooperation with Technical Ozone Unit of the Ministry of Environment and Sustainable Development of Colombia, with the aim of providing basic technical knowledge on the disposal of refrigeration and air conditioning appliances.

Abbreviations

ABS	Acrylonitrile butadiene styrene
CFC	Chlorofluorocarbon
COO	Chief operating officer
EEE	Electrical and electronic equipment
EPS	Extruded polystyrene
EU	European Union
GIZ	Deutsche Gesellschaft für Internationale Zusammenarbeit GmbH
GWP	Global warming potential
HC	Hydrocarbon
HCFC	Hydrochlorofluorocarbon
HFC	Hydrofluorocarbon
HIPS	High impact polystyrene
IBC	Intermediate bulk container
IGES	Institute for Global Environmental Strategies
NIRS	Near infrared reflectance spectroscopy
ODP	Ozone depletion potential
ODS	Ozone depleting substances
PBB	Polybrominated biphenyl
PBDE	Polybrominated diphenyl ether
PCB	Polychlorinated biphenyl
PP	Polypropylene
PS	Polystyrene
PSIG	Pounds per square inch gauge
PUR	Polyurethane rigid
PVC	Polyvinyl chloride
SSS	Sliding spark spectrometer
TEAP	Technology and Economic Assessment Panel of the Montreal Protocol
UNEP	United Nations Environment Programme
WEEE	Waste of electrical and electronic equipment

1. INTRODUCTION

A common approach in waste management aiming for recycling economy follows the ‘waste hierarchy’ strategy¹: **prevention, preparing for reuse, recycling, recovery and, finally, disposal** (which includes landfilling and incineration without energy recovery). This approach ought to be followed when drafting waste policies and managing waste at the operational level. It not only applies to solid waste but also to waste from electrical and electronic equipment (WEEE). WEEE is a waste stream that deserves special attention since it is growing rapidly, with 20 to 50 million tons being discarded per year (Ongondo et al., 2011). **WEEE can contain hazardous waste and can cause severe environmental and health problems** in the absence of proper waste management.

This **guideline should help to improve proper waste management practices** for a particularly important WEEE group: domestic refrigerators and air conditioners. These appliances are especially important because:

- they are mass products, found in almost all households worldwide;
- beyond the typical hazardous components in WEEE, these appliances also often contain refrigerants and foam blowing agents (the latter only in refrigerators) with a high global warming potential (GWP) and ozone depletion potential (ODP), thereby damaging the ozone layer and contributing to global warming if released uncontrolled to the environment.

This guideline addresses both environmental waste management companies and regional or local environmental authorities. Various questions arise when domestic refrigerators and air conditioners reach their end-of-life and are subject to dismantling. This guideline gives answers to key questions in the various chapters, as shown in Figure 1.

¹ For principle and further definitions, see Directive 2008/98/EC. The directive also introduces the ‘polluter pays principle’ and the ‘extended producer responsibility’.

Figure 1: Key questions addressed in this guideline that help to facilitate proper waste management of refrigerators and air conditioners

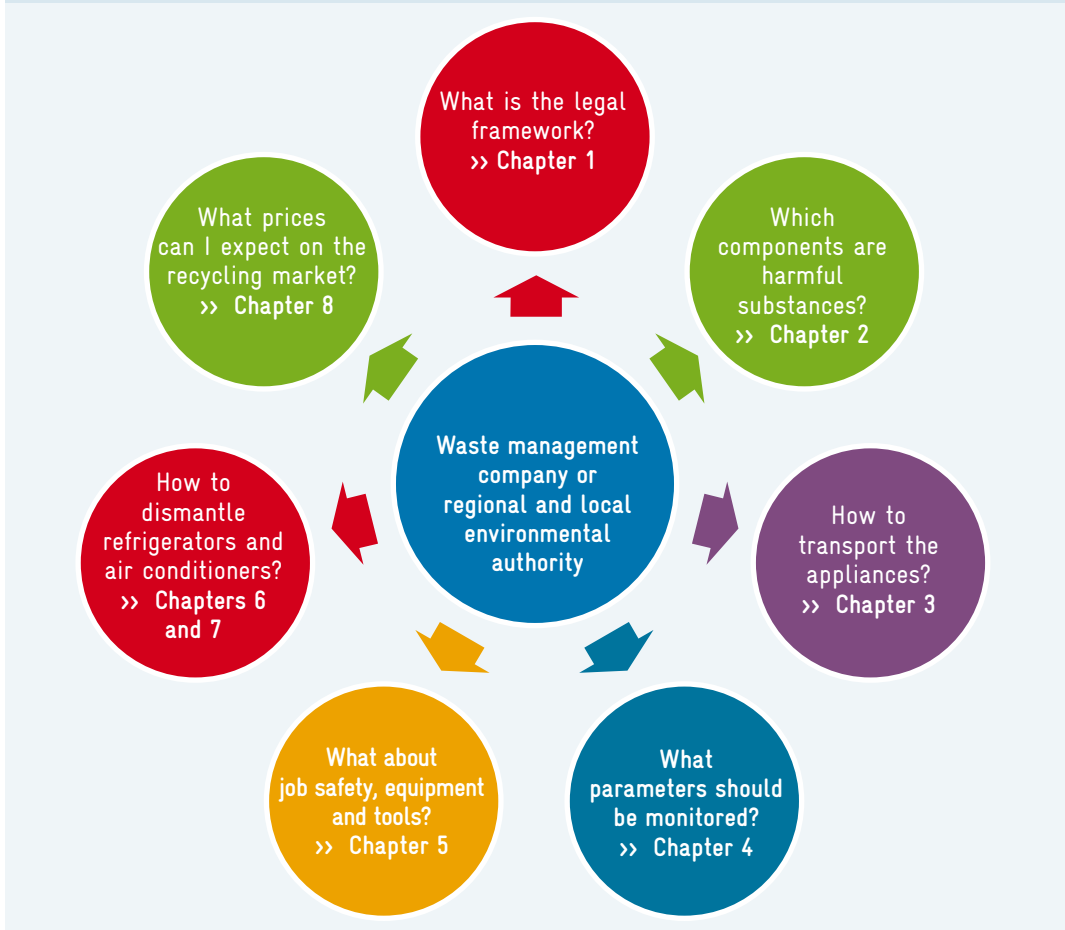

It is important to note that a successful waste management of these appliances requires a **sound regulatory framework**. As discarded refrigerators and air conditioners are considered as WEEE, but also contain critical refrigerants and blowing agents, a comprehensive regulatory framework should address both aspects (Figure 2). Of course, an established regulatory framework should include other equipment containing ODS and F-gases.

The European Union (EU) has a comprehensive regulatory framework in place regarding both aspects: WEEE Directive 2012/19/EU², ODS Regulation (EC) 1005/2009³ and F-gas Regulation (EC) 517/2014⁴.

² <http://eur-lex.europa.eu/LexUriServ/LexUriServ.do?uri=OJ:L:2012:197:0038:0071:en:PDF>, last access 3 June 2017.

³ <http://eur-lex.europa.eu/LexUriServ/LexUriServ.do?uri=OJ:L:2009:286:0001:0030:EN:PDF>, last access 3 June 2017.

⁴ <http://eur-lex.europa.eu/legal-content/EN/TXT/PDF/?uri=CELEX:32014R0517&from=DE>, last access 3 June 2017.

Figure 2: Regulatory framework for a successful management of ODS and HFC containing WEEE, such as refrigerators and air conditioners

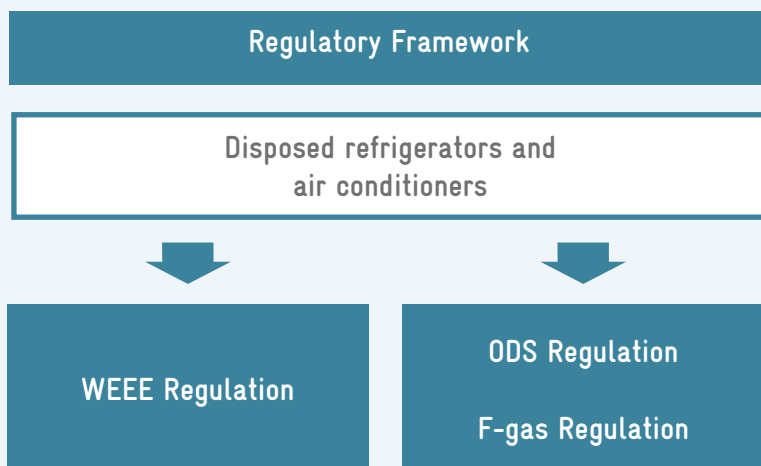

BOX 1

THE IMPORTANCE OF THE PROPER WASTE MANAGEMENT OF REFRIGERATORS AND AIR CONDITIONERS TO THE ENVIRONMENT

Lots of discarded appliances ...

Refrigerators are found in almost every household, while air conditioners play a dominant role in hot climates. Particularly in developing countries, air conditioners are increasingly becoming popular products: the world's production of domestic refrigerators and air conditioners numbers around 100 million units per year. Globally, the number of domestic refrigerators in use is estimated to be between 2 and 2.3 billion units (UNEP RTOC, 2015), the stock of residential split air conditioners is estimated to be around 700 million units (GIZ, 2014). Considering the average lifetime of the equipment, between 75 and 90 million domestic refrigerators and about 45 million split air conditioners enter the waste stream each year – a massive environmental threat if these appliances are not properly dismantled at their end-of-life.

Lots of hazardous components ...

- The most important critical refrigerants commonly found in these appliances: CFC-12, HCFC-22, HFC-410A, HFC-32, ammonia solution containing chromium-VI
- The most important critical blowing agents: CFC-11, HCFC-141b
- Mercury
- Printed circuit board components
 - Lead
 - Cadmium
 - Hexavalent chromium
- Polychlorinated biphenyl (PCB) in capacitors
- Polybrominated biphenyl (PBB) and polybrominated diphenyl ether (PBDE) in plastics as flame retardants

The impact on the global climate and ozone layer ...

- If not properly dismantled, a chlorofluorocarbon (CFC) containing domestic refrigerator will release 0.56 ODP kg and 3.6 tons CO₂eq. The latter corresponds to a flight from Colombia to Spain.
- If not properly dismantled, a spilt residential air conditioner containing R-22 will release 0.08 ODP kg and 2.6 tons CO₂eq.

When refrigerators and air conditioners are subjected to proper waste management, there are **various benefits**:

- the **protection of the ozone layer and climate system** as well as the prevention of releases of toxic substances polluting the ecosystem,
- **saving (depleting) raw materials**,
- **economic benefits from the resale of valuable materials**.

Not only fossil fuels but also metals and other rare materials, as found in refrigerators and air conditioners, are depleting raw materials and should thus be part of the circular economy. Furthermore, these appliances contain valuable materials. While this might be common knowledge for components such as the compressor, the same is not always true for plastics and other parts. A sound understanding of the returns from the various components recovered is essential to successfully run a WEEE company and to (over-) compensate the costs for the adequate handling and destruction of hazardous components.

BOX 2

THE IMPORTANCE OF PROPER WASTE MANAGEMENT OF REFRIGERATORS AND AIR CONDITIONERS FOR HUMAN HEALTH (GIZ, 2013; MODIFIED)

Hazardous substances	Where are they found?	How are they released?	Why are they dangerous?
Lead	<ul style="list-style-type: none"> • Solder 	<ul style="list-style-type: none"> • Heating up solder 	<ul style="list-style-type: none"> • Heavy metal accumulates in body tissue through unprotected contact – kidney damage
Cadmium	<ul style="list-style-type: none"> • Contacts • Colouring of plastic casing 	<ul style="list-style-type: none"> • Burning or heat treatment 	<ul style="list-style-type: none"> • Brain damage, even death
Mercury	<ul style="list-style-type: none"> • Switches • Sensors • Contacts 	<ul style="list-style-type: none"> • Heat treatment • Shredding 	<ul style="list-style-type: none"> • Nerve toxin, deadly in small doses • Severe polluter of water, soil, air
Hexavalent chromium	<ul style="list-style-type: none"> • Plating • Anti-corrosion agent • Pigment in plastics • In NH₃ refrigerants 	<ul style="list-style-type: none"> • Melting • Burning plastics 	<ul style="list-style-type: none"> • Causes cancer
Flame retardants: Polychlorinated biphenyl Polychlorinated diphenyl ether	<ul style="list-style-type: none"> • Plastic casing and housing • Plastic wiring and cables • Printed wire boards 	<ul style="list-style-type: none"> • Melting • Burning plastics • Shredding 	<ul style="list-style-type: none"> • Causes cancer

In the end, this guideline focuses on the manual dismantling of refrigerators and air conditioners. While industrialised countries often use automated crushing units for the further processing of refrigerators and air conditioners, many developing countries lack the financial resources and quantity required to make such technologies economically viable. Moreover, manual dismantling offers some **considerable advantages, in particular in low-income countries:**

- employment opportunities and thereby income, particularly also for population segments with low levels of education,
- high degrees of homogeneously sorted plastics and metals are possible, which are valuable goods on the recycling market.

However, a certain expertise is indispensable when dismantling these appliances, in particular because of the existing hazardous components (see Box 2). Thus, there is a need to train (possibly also to certify) employees working in this field. Recycling companies in Europe often offer crash courses for newcomers, which comprise around 200 teaching hours.

BOX 3

'BEST PRACTICE' AND MANUAL DISMANTLING OF FOAM FROM REFRIGERATORS

Please note that this guideline does NOT present 'best practice' when describing the manual dismantling of foam from refrigerators! Generally, it is recommended to process refrigerators in encapsulated crushing machines to recover the blowing agents from the foam. Manual dismantling of foam will result in a blowing agent loss of 10 to 33% (Öko-Institut, 2010).

However, we still describe this procedure of manual dismantling, acknowledging the reality in many developing countries, which lack the financial resources for such recovery systems (stage II system, see Box 7) in the magnitude of EUR 2 to 4 million. Also, a critical amount of returned decommissioned refrigerators of about 100,000 units per year are necessary for the economic feasibility.

If the stripped foam pieces are burnt in high temperature incinerators, more than 70% of the blowing agents contained in the foam can be destroyed (assuming no further degassing from foam during storage and transport). This percentage might even be higher when entire refrigerators are processed in high temperature incinerators.

The guideline outlines possible successive technical upgrades to reach automated crushing with the recovery of blowing agents in chapter 9.

The following sources were taken into consideration to describe 'best practice' (apart from foam) unless specified otherwise:

- RAL 728, 2007. Rückproduktion von Kühlgeräten. Quality Assurance and Test Specifications for the Demanufacture of Refrigeration Equipment. Gütesicherung RAL-GZ 728,
- VDI 2343,
- DIN EN 50574 (VDE 0042-11): 2013-06 and EN: 50574:2012 + AC: 2012,
- LAGA 31, 2009. Mitteilung der Bund/Länder-Arbeitsgemeinschaft Abfall (LAGA) 31. Anforderungen zur Entsorgung von Elektro- und Elektronik-Altgeräten ('Requirements for the disposal of EEE').

2. COMPOSITION OF REFRIGERATORS AND AIR CONDITIONERS

Refrigerators are predominantly composed of ferrous metal, non-ferrous metal (brass, copper, aluminium, etc.) and plastics, which together make up approximately 80% of the weight (see Figure 3). Accordingly, the dominating parts regarding the weight are steel, the compressor, plastics and polyurethane rigid (PUR).

Figure 3: Average material composition of 1,000 refrigerators in Europe, as delivered to WEEE management companies (including types I, II and III, see chapter 4.1; Öko-Institut, 2007)

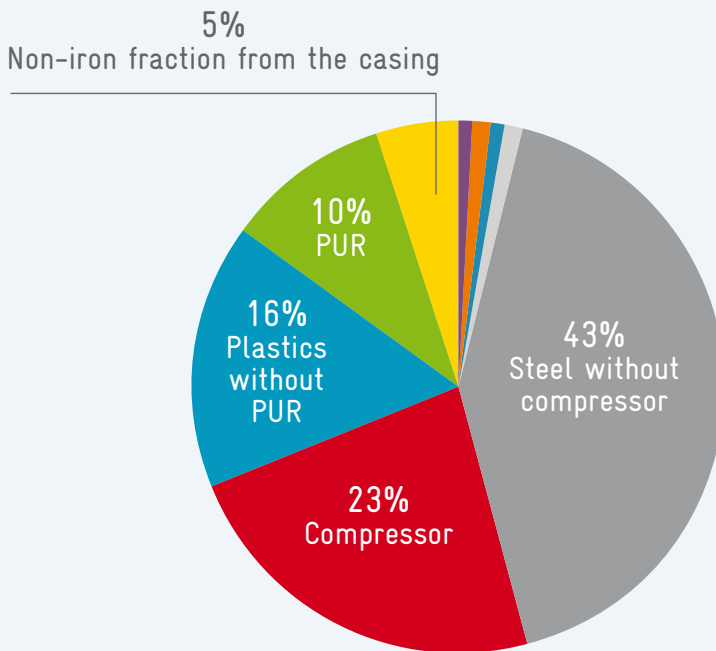

A more detailed division of the different components by weight is given in Table 1, whereby old CFC containing appliances are considered. The refrigerant CFC-12 and blowing agent CFC-11 make up less than 1% each, however, both of these components are the most critical parts from an environmental perspective and classified as hazardous waste.

Table 1: Detailed average material composition of 1,000 refrigerators in Europe, as delivered to WEEE management companies (including types I, II and III, see chapter 4.1; Öko-Institut, 2007)

COMPONENTS	CFC DOMESTIC REFRIGERATOR (KG PER 1 PIECE)	PER CENT IN EUROPE
Steel without compressor	17	43%
Compressor	9	23%
Plastics without PUR	6.2	16%
PUR	4	10%
Non-iron fraction from the casing	2	5%
CFC-11	0.34	0.9%
Water	0.25	0.6%
Glass	0.25	0.6%
Oil	0.2	0.5%
Cable	0.15	0.4%
CFC-12	0.115	0.3%
Rest	0.1	0.3%
Total	39.6	100%

This composition refers to refrigerators from domestic households in Europe. Different shares and absolute values might be found in other countries.

A similar picture is given for air conditioners, but here the compressor is the heaviest single part. Another main difference is the lack of foam or glass parts in air conditioners. Once the different components have been extracted during the dismantling process, the further recycling process of the components is the same. Table 2 shows the average percentage of the material composition by weight of air conditioners.

Table 2: Average material composition of self-contained air conditioners⁵ in Germany

MATERIAL	PER CENT
Steel	5.3
Compressor	39.3
Non-ferrous metals (12.7% copper, 8.3% aluminium)	21.0
Plastics	26.4
Printed circuit board	1.0
Refrigerant	2.4
Other materials	4.6
Total	100

2.1 Compressor and remaining steel

The compressor is the heaviest single part of refrigerators and air conditioners and consists of copper (8%), iron (57%) and cast alloy (35%). Only 15% of the compressors have a cast iron component instead of iron. These proportions are similar for refrigerators and air conditioners, only rarely do compressors in air conditioners have a higher proportion of iron⁶.

Steel is found not only in the cabinets of refrigerators, i.e. the outside of the fridges, but also the grid shelves are made of steel.

Condensing units in refrigerators are made of iron, whereas copper-aluminium is widely used in air conditioners. The only refrigerator type where copper-aluminium is used for the condensing units are commercial refrigerators.

⁵ Personal communication Georg Wallek, Managing Director (COO Recycling centre ESO GmbH in Offenbach).

⁶ Personal communication Georg Wallek, Managing Director (COO Recycling centre ESO GmbH in Offenbach).

2.2 Insulating foams

For insulation purposes, different foam types are used, namely PUR foam, sometimes glass wool and extruded polystyrene (EPS). PUR foams of older fridges contain CFC-11 and HCFC-141b as blowing agents. Domestic refrigerators generally contain between 4 and 10 kg of insulating polyurethane foam, which in turn contains about 5 to 10% of blowing agents by weight (Australian Department of the Environment, 2014), more often in the lower range.

In some instances, 5 to 10% of CFC-12 was added to the CFC-11 blowing agent in order to improve the foam properties⁷.

While CFC blowing agents have been used in both developing and developed countries in the past (now part of the bank), hydrochlorofluorocarbon (HCFC) blowing agents were predominantly used in developing countries. Nowadays, cyclopentane is used as a blowing agent in developed countries and increasingly also in developing countries. A pentane-air mixture can create explosive atmospheres under certain conditions, which must be accounted for when grinding the foam. CFC and HCFC blowing agents are considered as hazardous waste.

Refrigerators produced prior to 2000 are likely to contain CFCs as blowing agents. Thus, the foam must be treated in a special manner (see also chapter 9).

A greater diversity of insulation materials is found in commercial refrigerators, ranging from typical PUR foam (with blowing agent), foamed polystyrene (styrofoam) and mineral wool. Foamed polystyrene does not need to be treated in a special manner as it does not contain environmentally harmful blowing agents. The same holds true for EPS; however, mineral wool is more critical due to its carcinogenic properties.

Air conditioners normally do not contain foam.

⁷ Personal communication Jürgen Beckmann, Bayerisches Landesamt für Umwelt (Germany).

2.3 Plastics

A typical domestic refrigerator contains between 5 and 10 kg of plastics: mainly PS (polystyrene⁸), PP (polypropylene), ABS (acrylonitrile butadiene styrene) and sometimes PVC (polyvinyl chloride; Australian Department of the Environment, 2014). The dominating plastics of refrigerators are PS, which are used for the interior cladding. Fruit and vegetable trays are made of PP, less often ABS. Sometimes PVC is found on the top of refrigerators (part of enclosure), but this is rare. ABS and PP used for domestic refrigerators nowadays do not contain flame-retardants anymore and are thus valuable components for further use (chapter 8). The plastics of old refrigerators may still contain flame-retardants (e.g. brominated substances), but this is very rare⁹.

Plastic parts found in commercial refrigerators mainly contain PS, sometimes with additional aluminium coating.

Air conditioners consist predominantly of PP, but can also contain ABS. In air conditioners, it is more common to find flame-retardants.

Apart from flame-retardants, inorganic compounds such as antimony trioxide and halogen-free organic phosphorus compounds might be found. Other possible critical compounds are:

- inorganic pigments (titanium oxide, iron oxide, chrome yellow),
- organic pigments (phtalocyanine, chinacridone),
- heavy metal additives (Cr, Cd, Pb),
- plasticizer (e.g. phthalate).

2.4 Refrigerants

The refrigerant circuit contains refrigerant and oil. The dominant refrigerants are CFC-12 and HFC-134a, which have been replaced by R-600a in many countries¹⁰. Refrigerators other than domestic refrigerators with up to 180 litres may contain HCFC-22, propane, propane-butane mixtures or ammonia-containing refrigerants. Ammonia is particularly common in commercial refrigerators, e.g. those used as mini-bars in hotels in developed

⁸ More specifically HIPS (high impact polystyrene) is used.

⁹ Personal communication Georg Wallek, Managing Director (COO Recycling centre ESO GmbH in Offenbach).

¹⁰ Instead of giving the chemical substances group, often the symbol R (for refrigerant) is used, e.g. R-12. For more information, please see http://www.iifir.org/userfiles/file/webfiles/summaries/Refrigerant_classification_EN.pdf, last access 4 June 2017.

and developing countries. This refrigerant requires special treatment that differs from all other treatments. This is not only due to the properties of ammonia but also because of the hexavalent chromium found in the refrigerant. Refrigerators containing ammonia can be recognised by their typical condensing units, which are much coarser (see Figure 4). These refrigerators must be processed in specialised facilities, with regard to the refrigerant extraction process and refrigerant treatment (considering the good practices on refrigerants recovery and storage).

2.5 Printed circuit boards

The United Nations Environment Programme (UNEP) has found out that printed circuit boards make up to approximately 0.3% of the weight of large white goods¹¹, even though great differences exist (UNEP, 2013). Printed circuit boards contain minor quantities of metals and substances such as antimony, beryllium, cadmium, and chlorine in electronic components. Brominated flame-retardants and lead in solder can also be present (IGES, 2009; RMIT, 2006).

Refrigerators and air conditioners contain one or more printed circuit boards, in particular new domestic refrigerators and commercial refrigerators.

Apart from the hazardous substances associated with printed circuits, the circuit boards are of high value on the recycling market. Depending on the national legislation, they are either categorised as hazardous waste or e-waste and require environmentally sound management, especially when hazardous parts have not been previously removed. Sometimes only the boards without the components are considered as hazardous waste¹².

Figure 4: Refrigerator that uses ammonia as refrigerant. The condensing unit (cooling coil) is much coarser compared to refrigerators that use halogenated refrigerants or butane.



¹¹ White goods are large electrical appliances used domestically such as refrigerators and washing machines, typically white in colour.

¹² Personal communication Georg Wallek, Managing Director (COO Recycling centre ESO GmbH in Offenbach).

2.6 Mercury

Mercury can be found in the thermostats, sensors, relays, switches and lighting (see Figure 5). Mercury is rarely present in domestic refrigerators and air conditioners, but often present close to the lamp in the top cover of chest freezers. Whether mercury is present should be checked at the beginning of the dismantling process and, if found, it has to be extracted for special treatment. Mercury is a hazardous substance, thus a complete removal of parts containing mercury is of high priority.

Whether a differentiation between mercury switches and mercury-free switches can be made depends on the know-how and training of staff and is not recommended, and consequently not explained in more detail, in this guideline.

Figure 5: Parts containing mercury (right) are often found behind the lamp in the top cover of chest freezers (left).



2.7 Capacitors containing PCBs or electrolytes of concern

PCBs were used extensively in electrical equipment before the 1970s, e.g. in capacitors. New equipment produced since mid-1980 generally does not contain PCBs anymore. Therefore, only very old refrigerators and air conditioners (> 30 years) might still contain PCB capacitors.

Transformers of refrigerators and air conditioners that consist of copper and iron normally do not contain PCBs. Only the oil of transformers of larger appliances contains PCBs.

Depending on the year of production and each individual producer of the capacitor, PCB-containing capacitors might be marked as follows:

PCB, Chlordiphenyl, Clophen, Askarel, G, ISKRA, DB/764, 0219.(...), C2, CD, CPA, 3CD, 4CD, 5CD, CI, Clp, CPA30, CPA40, CPA50, Cp, CP25, CP30, CP40, CP50, P25, 10/070/65, 25/070/56, CB/764, KPM 1013¹³.

Capacitors free of PCBs can be marked with the following combinations of letters: MP, MKK, MPP, MKV, MFV, LK, LP.

Some producers of capacitors never used PCBs, e.g. Tesla, MM, Bosch, ITT. Capacitors with the label 'ELKO' are capacitors containing electrolytes and are free of PCB. However, the electrolytes also require special treatment and contain substances of concern.

These above mentioned combinations of letters are only examples. A list with most producers and possible PCB capacitors can be found on the webpage from *Chemsuisse*¹⁴.

As it appears difficult to differentiate the capacitors based on the labelling code, we recommend handling all capacitors as hazardous waste with treatment in specialised plants, where PCBs are destroyed at high temperature conditions after extracting the valuable components such as aluminium.



Figure 6: Location of capacitors (red arrows) potentially containing PCB



13 VDI 2343, Blatt 3, Sources 5 and 6.

14 http://www.chemsuisse.ch/files/97/DE_PCB_Hilfsmittel/80/Verzeichnis.pdf, last access 4 June 2017.

2.8 Oil

The compressors of refrigerators and air conditioners need oil. About 200 to 300 g are found in CFC-containing refrigerators (less oil in CFC-free refrigerators) and up to 1 kg in air conditioning equipment, depending on the size. A certain part of the refrigerant is dissolved in the oil, which is then also classified as hazardous waste. To remove the refrigerant component, special heat treatment is necessary (see Box 4). Only after the refrigerant compounds are removed from the oil, the oil can be recycled¹⁵.

BOX 4

IS THE SPECIAL HEAT TREATMENT OF EXTRACTED OIL RELEVANT?

There are several arguments for separating the refrigerant from the oil during stage I (see Box 7) in special heated oil separators (NOT heating the cylinders!), to further process the refrigerant and the oil.

When extracted refrigerants are incinerated (e.g. CFC):

- Many injection nozzles of high temperature disposal plants are having problems with oil, i.e. they get blocked quickly.
- The oil content increases the risk of soot in the exhaust and thereby greatly increases the probability of dioxin and furan production.

When recovered refrigerants are subject to reclamation (e.g. HFC-134a):

- Reclaim units can only process pure refrigerants (no mixtures of different refrigerants) with very little oil content.

Generally, the determination of the refrigerant recovery rate (see also chapter 4) has shortcomings when the oil has not been removed before. This is because the amount of oil (within the appliances) is often not known and therefore has to be estimated, which introduces another source of potential errors.

Without special heat treatment, the extracted oil will have a CFC concentration above 2 g per kg oil and thus should be destroyed at high temperature conditions. However, following the general principle of waste management (see chapter 1), oil should be reused instead of being destroyed at high temperatures. In case special heated oil separators are not available, mobile recovery units with oil separator can be used (see Box 6).

¹⁵ Depending on the refrigerant, different oils are used. However, this aspect is only relevant when oil is recovered for reuse and can be neglected when the waste oil is subject to final destruction.

2.9 Glass

Refrigerators contain a glass fraction, which is below 1%. The glass is used within the refrigerators as shelves and can easily be extracted before the dismantling process.

Air conditioners generally do not have a glass fraction.

2.10 Non-iron fraction from enclosure

Non-iron fractions are brass, copper and aluminium. The condenser of air conditioners generally consists of copper and aluminium. These are materials with a high thermal conductivity. Brass is rarely used, and if so, it is used for connections in air conditioners but normally not in refrigerators.

2.11 Summary of hazardous substances

The most critical and known hazardous substances of refrigerators and air conditioners are the refrigerants CFC-12, HCFC-22, HFC-134a, R-410A (HFC blend), HFC-32, other HCFC or HFC-based mixtures and ammonia solutions containing chromium-VI. The most important critical blowing agents found in PUR of refrigerators are CFC-11 and HCFC-141b. Other hazardous substances are:

- mercury (only chest freezers),
- printed circuit boards components in air conditioners and refrigerators:
 - lead,
 - cadmium,
 - hexavalent chromium,
- PCB in capacitors (refrigerators and air conditioners),
- PBB and PBDE in plastics as flame retardants (higher probability to find these substances in air conditioners than in refrigerators).

3. TRANSPORTATION

To prevent the uncontrolled release of critical refrigerants, blowing agents or other harmful substances such as oil, special transport safety instructions should be followed. Regardless of whether transporting a single or several appliances, **refrigerators and air conditioners should be fastened to the transport vehicle** to avoid damage. Tension belts can be used but are not necessary if sufficient packing density is ensured.

When several appliances are transported, roller containers can be used. All the heat exchangers of the **refrigerators should face the same direction** at right angles to the direction of travel (Figure 7). It is recommendable to transport these appliances in an **upright position** (not upside down) and they should not be laid on their cooling coils. Piling up refrigerators randomly must be avoided. In order to minimise damage during transportation, it is recommended to fill up empty loading space, e.g. with loose doors of refrigerators. Furthermore, heavy appliances should be placed in the lowest layer, lighter and smaller items on top of the first layer, etc.

Figure 7: Suitable (left) and unsuitable (right) piling of refrigerators in a roller container

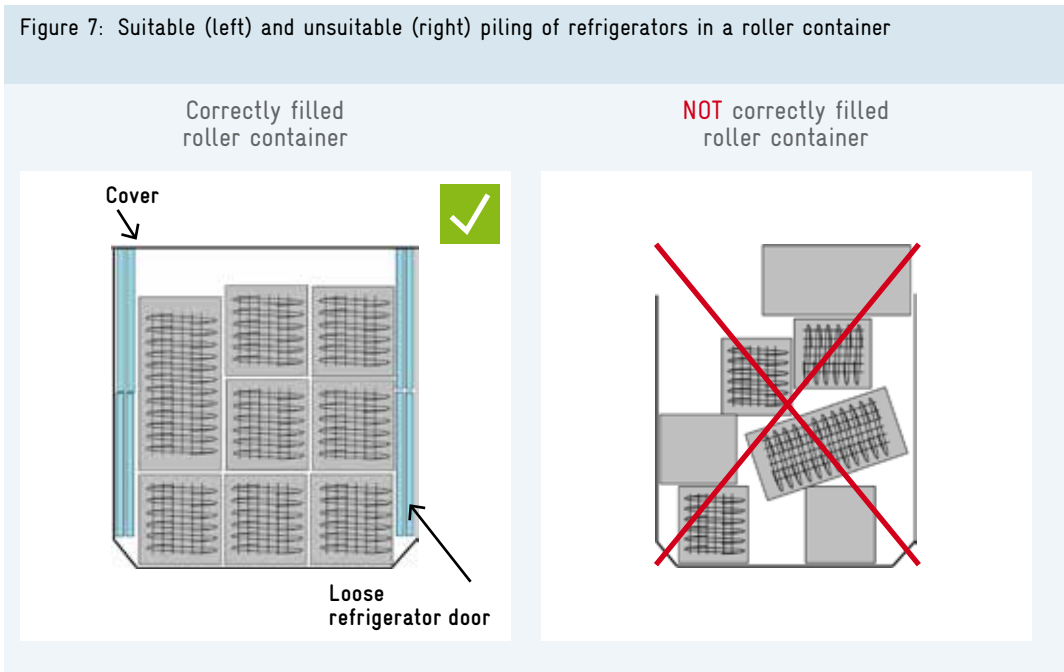

Reloading from one transportation system to another should be avoided as far as possible, because this always comes with the danger of damaging the systems. Roller containers or other transportation containers should be covered (lid) to ensure rain protection.

During transport, the containers must be protected against unauthorised entry to avoid the removal of items. Furthermore, at least two fire extinguishers should be aboard the transport vehicle (see Ministerio de Ambiente, Vivienda y Desarrollo Territorial, Colombia, 2010). When loading or unloading, the equipment should be handled with care and not be knocked down or dropped.

When the appliances arrive at the WEEE management companies, the equipment should be sorted according to the different sizes (see also chapter 4), but also by the refrigerant. There should be a delimited area within the factory building for each type of sorted equipment (see Figure 8). **Piling up the equipment in several layers within the factory building should be avoided.**

Pre-sorting strongly facilitates the later processing of the equipment: when appliances with different refrigerants are processed together (which strongly depends on the stage I – see Box 7, Figure 19 – extraction technology and the heated oil separator), then all these appliances can be stored in the same area of the building.

For general aspects on collection systems, please see the ‘Guideline to establish a collection system for equipment containing ODS’ (GIZ, 2017).

Figure 8: Sorted refrigerators in the factory building of a WEEE management company after the equipment had been delivered



4. RECORD KEEPING, RECOVERY RATES AND CATEGORIES

Every waste management company should have its own **monitoring and information system** to control the following:

- WEEE input versus output: tonnage of WEEE delivered (= input) versus recovered material (= output),
- recovery rates of hazardous substances, at least of refrigerants.

4.1 Categories of equipment

Therefore, appliances and materials have to be categorised. For appliances, this largely depends on the country-specific systems that are used and the categories should reflect the market. The following differentiation can be used for refrigerators:

- **Type I appliance**
‘Domestic fridges’: These are refrigerators of a typical domestic design with a storage capacity of up to 180 litres. The appliances may or may not be equipped with a separate deep-freeze compartment.
- **Type II appliance**
‘Domestic fridge-freezers’: These are refrigeration appliances of a typical domestic design with a storage capacity ranging from 180 to 350 litres. Generally, these appliances have a separate deep-freeze compartment.
- **Type III appliance**
‘Domestic chest freezers and upright freezers’: These are deep-freeze appliances of a typical domestic design with a storage capacity of up to 500 litres.
- **‘Commercial refrigerators’**
These are any appliances whose construction and size differ from those mentioned above and that are predominantly used for commercial purposes.

With regard to air conditioners, two main different types exist: stand-alone units (plug-in systems) and split systems. These types are then subdivided according to size and capacity.

4.2 WEEE input versus recovered materials

This approach considers the tonnage of WEEE delivered (input) versus the tonnage of materials recovered (output), illustrated in Figure 9. The definition of categories depends on the national legislation and basically reflects the categories that have been defined under the national collection scheme (in case one exists¹⁶).

Irrespective of whether one considers manual dismantling or an automated crushing procedure, we suggest using the categories from Figure 9 for recovered materials. Depending on the resources available, more categories might be introduced and weighed accordingly. This kind of **monitoring seems indispensable for establishing a robust business plan** of a WEEE management company and provides control over the recovery effectiveness.

Figure 9: Monitoring system of WEEE manager: mass balance approach, balancing the tonnage of WEEE delivered (left) versus the tonnage of materials recovered (right)

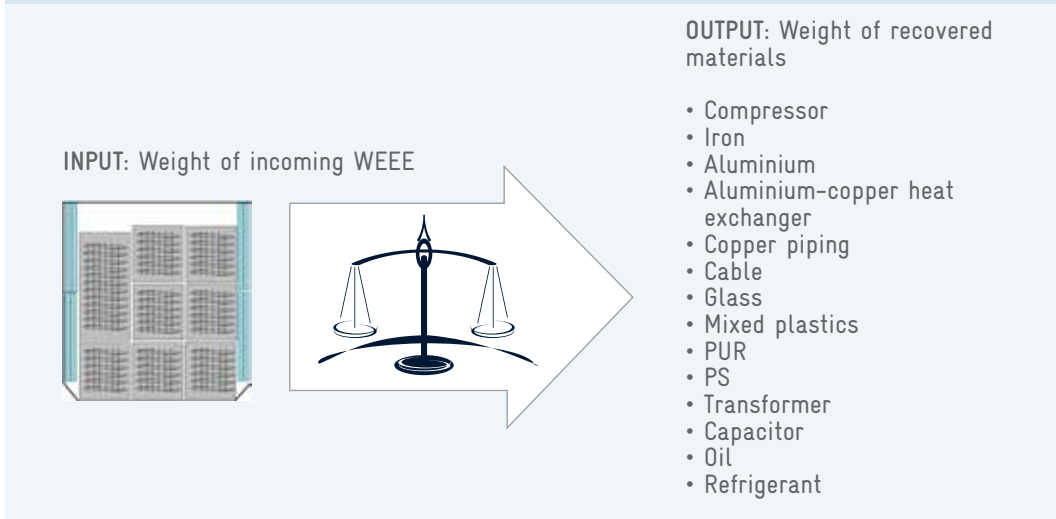

¹⁶ In case a collection scheme has not been established, please see 'Guideline to establish a collection system for equipment containing ODS' (GIZ, 2017).

4.3 Determination of refrigerant recovery rates

Apart from the mass balance approach described above, all refrigerators and air conditioners delivered to WEEE managers should be recorded according to certain characteristics. Therefore, it is advisable to keep a log to record the number of refrigerators and air conditioners and other characteristics, such as:

- type of equipment (for categories, see chapter 4.1),
- refrigerant type (see label on the fridge or the compressor, see Figure 10),
- refrigerant circuit defect or intact (see Box 5).

Each worker at the disassembly line should record the number of appliances on a daily basis. Table 3 might be used for this purpose, designed for stage I (see also Box 7). At the end of the week, this data should be digitalised (e.g. using an Excel file).

The procedure in detail

Recovery rates should be constantly calculated, at least once per week, after the hard copy template (Table 3) has been transferred into an electronic version. For this, the following key formula is used:

$$\text{Recovery rate} = \frac{\text{amount of recovered refrigerant}}{\text{expected amount of refrigerant}}$$

Calculation of amount of recovered refrigerant:

- Note the display value (weight) of the pressure vessel in the morning before work (please see chapter 6, step 10).
- Extract the refrigerant of all units during working time and fill out the hard copy template (see Table 3).
- Note the display value (weight) of the pressure vessel at the end of the working day.
- The difference of the display values (evening and morning) represents the amount of recovered refrigerant.

Figure 10: Pressure vessel on scales, containing the recovered refrigerants which have been extracted



Pressure vessel with extracted refrigerant

Table 3: Template for record keeping of refrigerators and air conditioners. The fields with orange filling are the units which are used for determining the recovery rate.

CALEN-DAR WEEK:	REFRIGERATORS		AIR CONDITIONERS					
	ODS and F-gases (CFC, HCFC, HFC)		Refrigerants without chlorine and fluorine (Propane, R-600a, hydro-carbon mixtures, etc.)		ODS and F-gases (CFC, HCFC, HFC)		Refrigerants without chlorine and fluorine (Propane, R-600a, hydro-carbon mixtures, etc.)	
	Refrigerant circuit defect, e.g.: • compressor absent • piping damaged	Refrigerant circuit undamaged (i.e. no visible damage)	Refrigerant circuit defect	Refrigerant circuit undamaged	Refrigerant circuit defect	Refrigerant circuit undamaged	Refrigerant circuit defect	Refrigerant circuit undamaged
Monday	8	I				II		
Tuesday	4		III				I	
Wednesday								
Thursday								
Friday								
	Total number of units							

Please note that a refrigerant-oil separation process is recommended before (see Box 4). When the separation process is done overnight (to ensure that all refrigerants were removed from the refrigerant-oil mix (see Box 6), the display reading will not be taken at the end of the day but the next morning.

Calculation of **expected amount of refrigerant**:

- Multiply the number of undamaged units containing ODS or F-gases (Table 3, orange column) with the (weighted) average initial charge of the units.
- The initial charge values can be derived from the product labelling (see Figure 11, left).

Figure 11: Indication of the refrigerant type on the product labelling (left) and on the compressor (right). The product label also indicates the refrigerant charge.

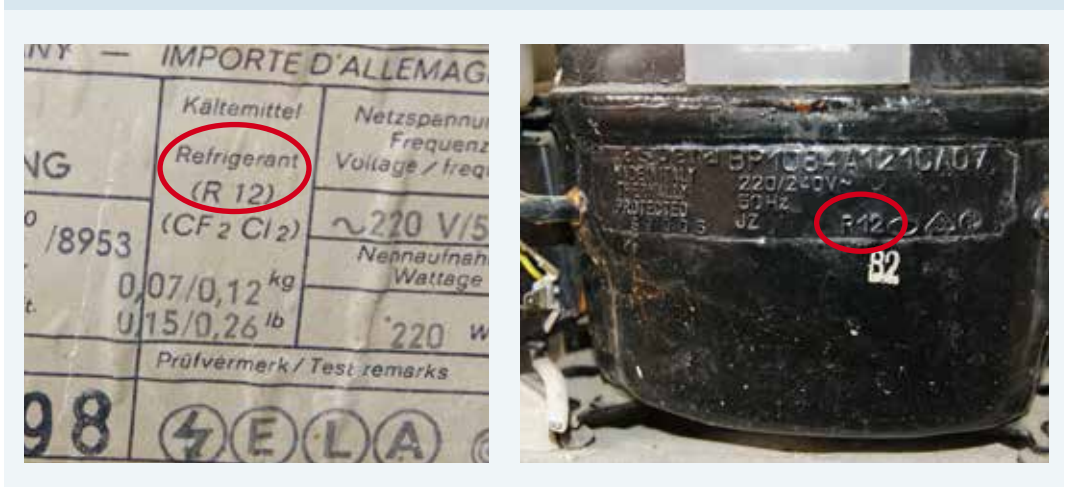

This process is done separately for refrigerators and air conditioners. However, it is not done separately for different appliances (e.g. refrigerator types I, II, etc.). Ideally, a weighted average initial charge value is used in the formula. This value can be derived by considering the charges together with the number of the different equipment that is returned.

It is recommendable to control the extraction process at least once per year¹⁷. Official commissioned personnel generally do this. The refrigerant extracted should amount to at least 90% of the refrigerant contained, based on information on the nameplate. It is recommended to perform this test with 100 refrigerators once per year (100 waste appliances with undamaged cooling circuits of which 60 are type I appliances, 25 are

¹⁷ In Germany TA-Luft Nr. 5.4.8.10.3/5.4.8.11.3.

type II, and 15 are type III) and to compare the amounts extracted with the amounts given on the label. Once a refrigerator in a 100-unit test is found to be defect, it has to be replaced by an intact fridge¹⁸.

Important: if the test shows a recovery rate < 90%, the recovery equipment must be checked, repaired or renewed!

BOX 5

IS THE REFRIGERATION CIRCUIT DEFECT?

For the purposes of determining the recovery rates, only appliances with an intact refrigeration circuit are relevant. But how can we know whether the circuit is defect or not?

- Visual check: some components of the system (e.g. compressor) are missing or piping is obviously damaged. → defect
- Check manometer: there is no pressure on the systems? → defect
- Inspection glass: there is no blistering in the inspection glass? → defect

The defect units are subject to the manual dismantling process as usual. No refrigerant extraction is necessary because the refrigerant has already escaped from the system.

¹⁸ For more information, please see RAL 728, 2007, p. 18 ff.

5. EQUIPMENT, TOOLS AND JOB SAFETY

5.1 Job safety

The following basic personal protection elements are recommended for the employees of a WEEE company that conduct the dismantling process:

Figure 12: Equipment for employees conducting the manual dismantling of refrigerators and air conditioners

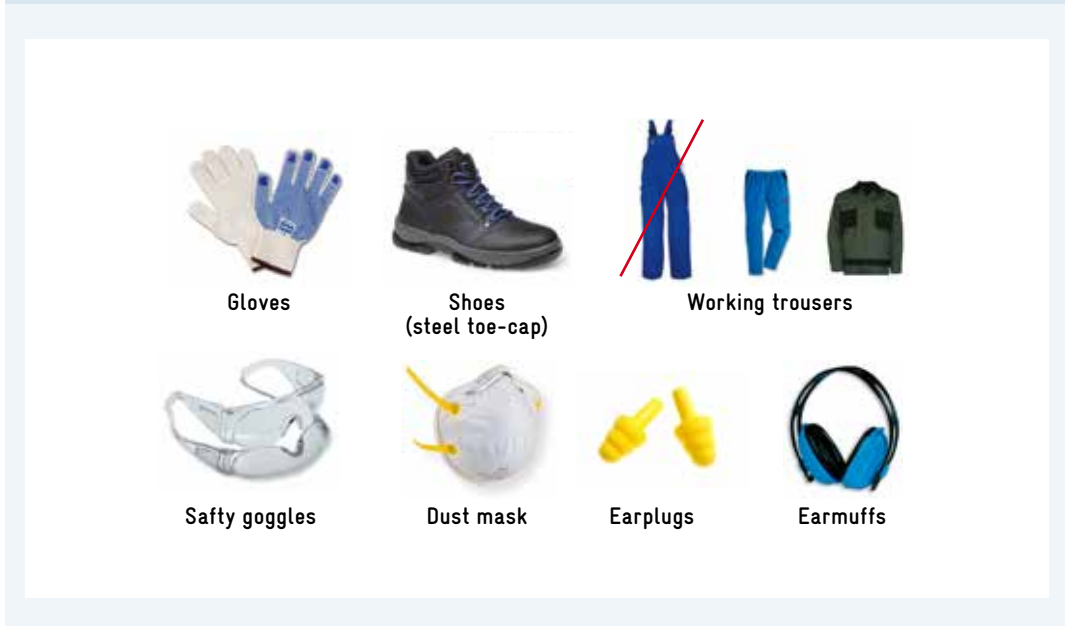

Trousers with shoulder fastenings are not recommended due to the danger of getting caught on something.

5.2 Necessary equipment of WEEE management companies

Similarly, the WEEE management companies need to be equipped with several items, as displayed in the following figures. Figure 13 shows basic tools which are needed for the dismantling process and Figure 14 shows a disassembly line (left) which allows the tilting of refrigerators to extract the refrigerants at the lowest point, using piercing pliers (Figure 14, right).

Figure 13: Basic tools of a WEEE management company



Figure 14: Disassembly line for extracting refrigerants and the associated piercing pliers



Finally, Figure 15 shows a special heated oil separator (left), a pressure vessel with scales for the extracted refrigerant (upper right) and an ASF¹⁹ oil container to store the waste oil (bottom right).

Figure 15: Necessary equipment after the refrigerant has been extracted: special heated oil separator (left), a pressure vessel with scales (upper right) and an ASF oil container for the waste oil (bottom right)



Separating refrigerant-oil mix



Pressure vessel and scales



Oil container

Disassembly line, piercing pliers and heated oil separator are generally tailor-made to fit the customers' needs; the design strongly depends on the number of appliances and the type of refrigerant. Consequently, we cannot give general recommendations about which recovery system to use. However, one can distinguish between two basic types:

- stationary recovery systems (standard design for around 60 refrigerators per hour),
- mobile recovery units.

¹⁹ ASF containers belong to the category of intermediate bulk container (IBC) and are used to collect and transport flammable fluids or fluids hazardous to water.

Typically, stationary recovery systems have the dimensions 2,000 x 1,200 x 1,800 mm with around one ton of weight, and they work with a negative pressure of 0.8 bar. In particular, small WEEE management companies with few refrigerators to process will not start off by installing stationary recovery systems; in that case, a mobile recovery unit appears more suitable (see Box 6).

R-600a refrigerators can also be treated with such recovery units, accounting for safety measures (flammability of R-600a). Even for ammonia refrigerators special modules exist. It depends on the number of fridges as to whether these investments are economically viable. The providers of these systems offer advice²⁰.

Finally, WEEE management companies need several containers and boxes for storing WEEE and the recovered components. Apart from the oil and refrigerant storage (Figure 15), no special containers and boxes are needed.

Generally, the bigger the container, the lower the transportation costs. For this reason, WEEE management companies might be interested in large containers, but of course this depends on the amount of WEEE to be processed. WEEE, including refrigerators and air conditioners, are ideally delivered in roller containers (Figure 16, left); these can also be used for the onward transport of recovered components to other facilities. Alternatively, smaller containers can be used (Figure 16, right).

Figure 16: Roller container (left) and smaller 7 m³ skip (right) for the transport of WEEE and recovered components



²⁰ Examples of stage I system providers: <http://www.en-pro.de>, last access 4 June 2017, and <http://www.herco-gmbh.com/en>, last access 4 June 2017.

Within the WEEE management companies, smaller containers and boxes are also used. Simple containers made of iron mesh are suitable for the majority of components: cables, compressors, cooling coils, etc. (Figure 17, left). For intermediate storage, i.e. for employees directly working at the disassembly lines, simple plastic boxes may be used (Figure 17, right).

Figure 17: Iron mesh container, here shown with cables (left); smaller plastic box for intermediate storage, here shown with copper components (right)



Tilting skips are particularly suitable for glass (Figure 18, left), while round plastic drums with sealable lids should be used for hazardous components, such as circuit boards, mercury-containing switches, etc. (Figure 18, right).

Figure 18: Tipping tank (left) and plastic containers (right) for recovered materials



5.3 Site requirements for the WEEE management companies

There are some site requirements when stage I (see Box 7, Figure 19) systems are established, including temporary storage of equipment. These requirements mainly refer to:

- construction,
- noise and dust protection,
- plant safety,
- preventive fire protection,
- water and soil protection.

Construction

Verifiable data on statics for the foundation and the building must be checked before installing a stage I system. The area should then be protected with a fence and lockable gates that have to be closed during non-operating hours to avoid unlawful intrusion. Areas which are used for the storage of equipment and the dismantling itself should be paved but separated from each other and marked as such. The floor should be smooth and seamless, in particular when dealing with mercury.

Noise and dust protection

Stage I systems should be installed in industrial rather than residential areas to avoid the impact of traffic and noise on residents. The noise from vehicles delivering e-waste and picking recovered materials must be accounted for during the planning process.

The noise-emitting phases of the dismantling process should take place within buildings. Nationally defined maximum noise levels must be considered, both for noise sources (emissions) and sound impact at certain distances (noise pollution). Gates, windows and doors should only be opened if necessary and kept closed at night.

Besides the dust masks of the employees, mobile or stationary dust collection systems are recommended to avoid small particles from entering the lungs during manual foam stripping. It is important that the filter can effectively capture particles of at least 5 micron (micron is a synonym for μm and $1 \mu\text{m} = 10^{-6} \text{m}$).

Plant safety

The physical and chemical properties of the refrigerants (e.g. lower and upper explosion limit) must be considered to avoid the creation of explosive atmospheres within the building. Ignition sources (e.g. open fire, cigarettes) must be excluded. If necessary, an air ventilation system can ensure a sufficient air exchange rate. Automatic monitoring of hydrocarbon concentrations within the building might provide the necessary indicators.

When reaching critical explosion limits, operation must be shut down. The standard EN 378 can be used as an assessment guideline on the creation of explosive atmospheres.

Preventive fire protection

A fire precaution regulation should be established in accordance with the local fire department. The key elements are an automatic fire detection system including a smoke or heat control system for smoke removal. In addition, ground plans providing an overview of the building and its components should be made available to the fire brigade. Sufficient water for firefighting must be available at all times.

Water and soil protection

Storage areas for refrigerators and air conditioners should have waterproof roofs with the provision for spillage control. Similarly, the area where the dismantling takes place requires waterproof roofing. The installation of a steel basin under the dismantling area is recommended to prevent refrigerants and oil from infiltrating the soil and groundwater.

It is recommendable to consider the national legislation for more details on these site requirements.

6. MANUAL DISMANTLING OF REFRIGERATORS

All operations described below (steps 1 to 23) belong to the so called **stage I** according to the commonly accepted definition²¹. Steps 24 to 28 refer to manual foam stripping (see also Box 3). Steps 1 to 23 include the removal of loose parts, extraction of refrigerant and oil, separating oil from refrigerant, removing capacitor and compressor including attached components, the condensing unit; and draining the compressor of oil. After that, the insulation foam will be removed manually from the refrigerator's cabinet. The orange colouring in Figure 19 indicates the steps that are covered by this guideline, the blue colouring highlights the steps from stage II which are not covered (see also Box 7 and chapter 9).

Figure 19: Overview of stage I and stage II processing and the steps which are covered by the guideline

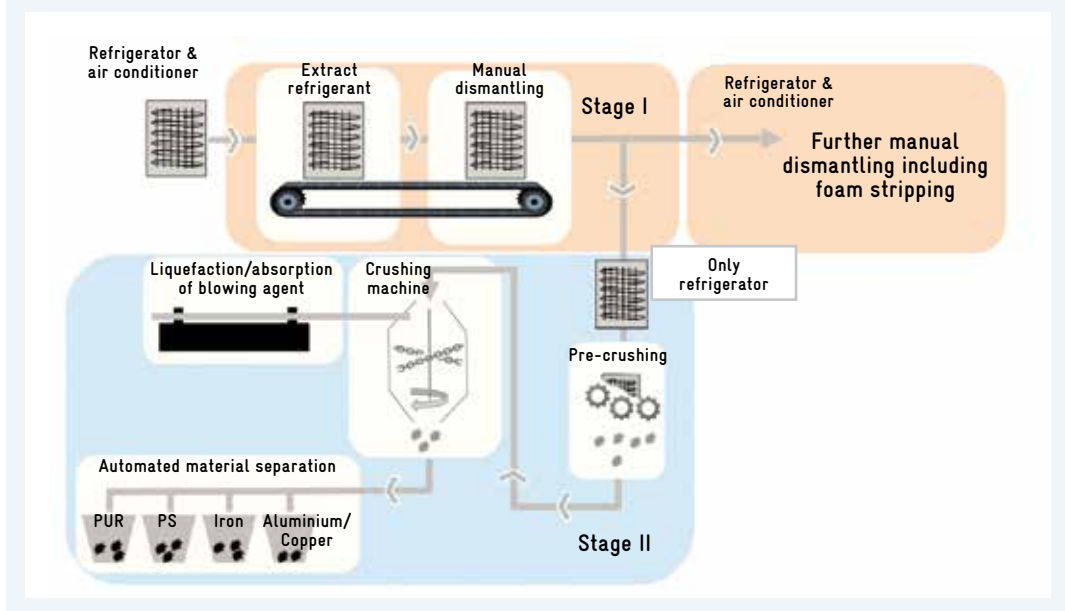

WEEE management companies must draw up detailed working instructions and **all employees should be briefed regularly on these working instructions**. Working instructions should be clearly visible in the working area. This chapter, delivered in a hard copy version, could be used as a guideline for employees. However, additional training appears inevitable.

21 See also Box 7 and VDI 2343.

STEPS FOR THE PROPER DISMANTLING OF REFRIGERATORS

Removal of all loose parts

STEP // 01



- The refrigerator is typically delivered with all interior parts.

STEPS FOR THE PROPER DISMANTLING OF REFRIGERATORS

Removal of all loose parts

STEP // 02

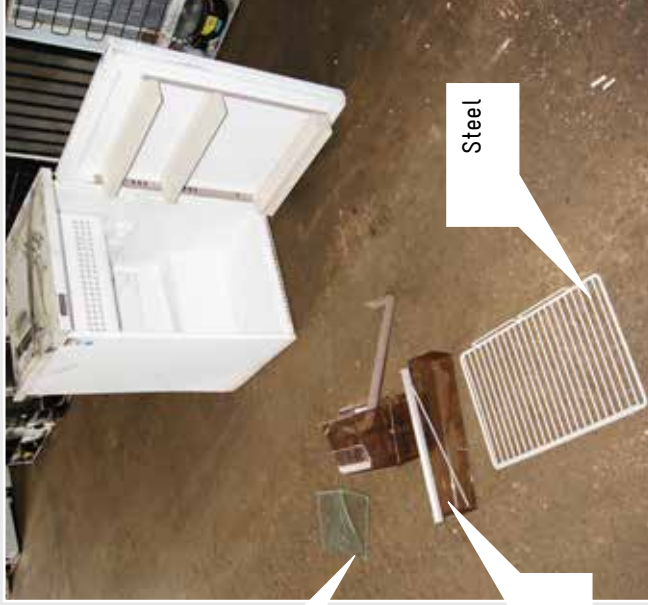

- Remove all loose parts of the fridge:
 - glass,
 - plastics,
 - steel.
- Plastics and steel are valuable materials.



STEPS FOR THE PROPER DISMANTLING OF REFRIGERATORS

Removal of all loose parts

STEP // 03

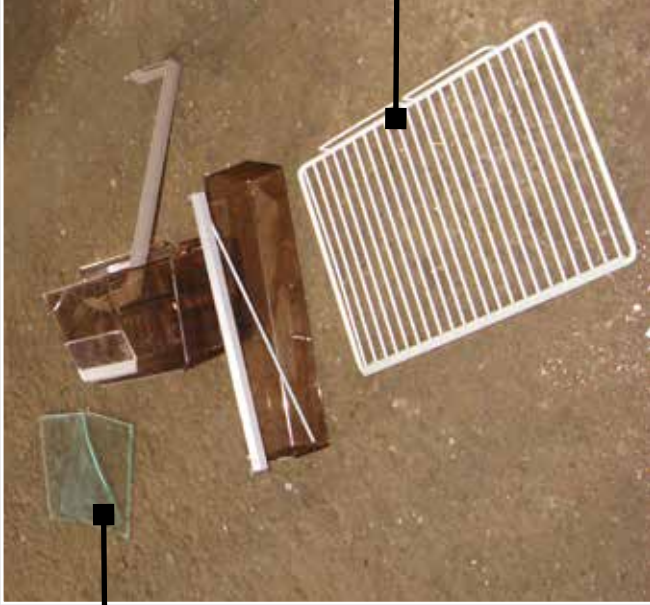

- Store the components in separate containers.



STEPS FOR THE PROPER DISMANTLING OF REFRIGERATORS

Removal of all loose parts

STEP // 04

- What to do with the plastics?

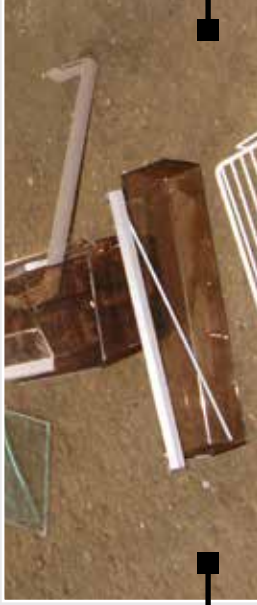

Symbol on plastic available?

- Separate plastics according to symbols.



No symbol on plastic available?

- Store plastic parts as mixed plastics in a container for later separation.



STEPS FOR THE PROPER DISMANTLING OF REFRIGERATORS

Removal of cable

STEP // 05

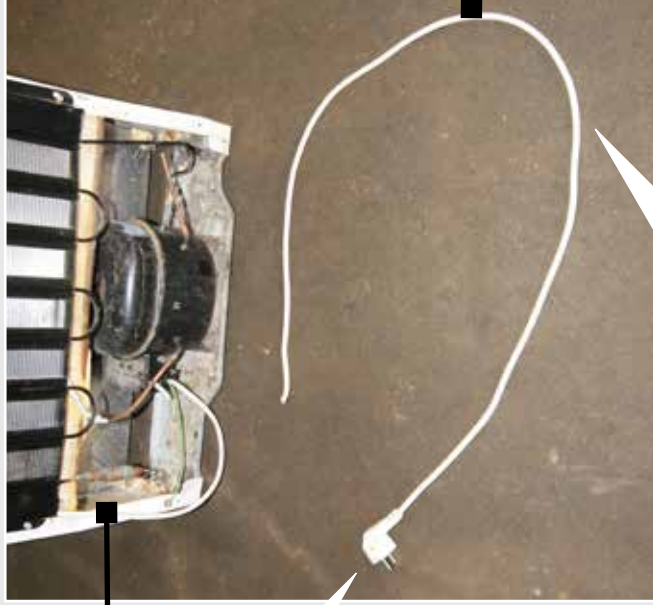

- Cut the plug-in cable.
- Plug-in cables are valuable components.
- Cutting the plug from the cable increase the value of the cable.

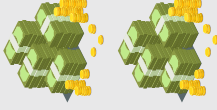

STEPS FOR THE PROPER DISMANTLING OF REFRIGERATORS

Switches of chest freezers might contain harmful substances!

STEP // 06



- Check the cover plate of the chest freezer for mercury-containing switches!
- Remove the plastic box at the cap and look for switches.



Here, no mercury switch was found.

STEPS FOR THE PROPER DISMANTLING OF REFRIGERATORS

Switches of chest freezers might contain harmful substances!

STEP // 07



Here, a mercury switch was found.

Store the mercury-containing switches in a separate container.



BOX 6

REFRIGERANTS ARE HARMFUL SUBSTANCES! DO NOT RELEASE THEM INTO THE ATMOSPHERE!

Portable recovery units (Figures A and B) can be used to extract refrigerants from refrigerators and air conditioners. To this end, appropriate cylinders (Figure D) must be connected with the recovery unit to store the recovered refrigerant. Due to the probability that recovered refrigerants are contaminated (mixed) with other refrigerants (e.g. R-410A), it is recommendable to use recovery cylinders with a maximum operating pressure of 400 PSIG (e.g. DOT-4BA-400). For the values of different service pressures, please see Table 1.

Portable recovery units should generally contain an oil separator (Figure B, e.g. WIGAM EASYREC120R100), an important feature for professional recovery. For units that are not equipped with an integrated oil separator (Figure A), a separate tool (Figure C, e.g. MASTERCOOL Recoverymate 69500) can be used to remove oil, contaminants and moisture. For this purpose, the cleaning tool is simply attached to regular refrigerant transfer hoses.

Depending on the extracted refrigerant type, the refrigerant can be reused after reclamation (e.g. R-134a or R-22) or recovered for destruction (e.g. R-12). Of course, different cylinders must be used for different refrigerant types. Using piercing pliers instead of line tap valves strongly simplifies and speeds up the extraction process! Piercing pliers (around EUR 70 to 80) can be combined with portable recovery units.

The extraction process is even more effective when larger extraction systems in combination with heated oil separators are used (see steps 8 to 11). See also Box 4 for a discussion on the differences.



Figure A:
Commonly used portable recovery unit for refrigerant extraction (left: side view, right: front view). This unit does not contain a built-in oil separator.



Figure B:
Mobile recovery unit with integrated oil separator



Figure C:
Tool to remove oil, contaminants and moisture as an attachment for a common recovery unit as shown in Figure A



Figure D:
Cylinder to store the recovered refrigerant

Table 4: Indication of maximum operating pressures and cylinder classification according to the U.S. Department of Transportation. Example: DOT4BA400 is designed for a maximum operating pressure of 400 PSIG, DOT4BW260 is designed for 260 PSIG.

REFRIGERANT (ASHRAE)	CLASS	SG 25 °C (77 °F)	30 OR 50 LB. CYLINDER	125 LB. CYLINDER	1,000 LB. CYLINDER
R-22	HCFC	1.2	4BA350	4BA300	4BW260
R-290	HC	0.49	4BA350	4BA300	4BW260
R-438A	HFC	1.15	4BA350	4BA300	4BW260
R-422D	HFC	1.2	4BA350	4BA300	4BW400
R-417A	HFC	1.15	4BA350	4BA300	4BW260
R-422A	HFC	1.14	4BA350	4BA300	4BW400
R-437A	HFC	1.18	4BA350	4BA300	4BW260
R-134a	HFC	1.2	4BA350	4BA300	4BW260
R-401A	HCFC	1.19	4BA350	4BA300	4BW260
R-401B	HCFC	1.19	4BA350	4BA300	4BW260
R-402A	HCFC	1.15	4BA400	4BW400	4BW400
R-402B	HCFC	1.16	4BA400	4BW400	4BW400
R-404 or R-507	HFC	1.05	4BA350	4BA300	4BW400
R-407A or R-407C	HFC	1.15	4BA350	4BA300	4BW400
R-408A	HCFC	1.06	4BA350	4BA300	4BW400
R-409A	HCFC	1.22	4BA350	4BA300	4BW260
R-410A	HFC	1.06	4BA400	4BW400	4BW400

STEPS FOR THE PROPER DISMANTLING OF REFRIGERATORS

Refrigerants are harmful substances! Do not release into the atmosphere!

STEP // 08



- Extract the refrigerant and the oil at the lowest point using piercing pliers.



Piercing pliers

STEPS FOR THE PROPER DISMANTLING OF REFRIGERATORS

Refrigerants are harmful substances! Do not release into the atmosphere!

- Piercing pliers are special pliers to extract the refrigerant.
- These pliers have a hollow needle and must be placed on the refrigerant copper pipe of the refrigeration circuit.
- The refrigerator/air conditioner must be tilted by a certain angle, so that the piercing pliers can be placed at the lowest point of the refrigeration circuit next to the compressor. In this way both refrigerant and oil can be extracted.
- The needle will pierce the copper pipe.
- A hex key allows the adjustment of a screw (at the end of the pliers) which influences the penetration depth of the needle.
- The pliers have a 'locking function' that keeps the pliers fixed to the refrigerant copper pipe (hands can be taken off).
- The piercing pliers have to be connected to an industrial extraction system with heated oil separator or a mobile recovery unit.
- Alternatives to piercing pliers are for example drill-heads.

A flexible tube connects the piercing pliers with a heated oil separator (see Step 9) or a mobile recovery unit (see Box 6).

Hex key to adjust the piercing needle



Piercing pliers

It is also recommendable to extract hydrocarbon refrigerants (e.g. R-600a) for recycling or disposal with the recovery units. However, it greatly depends on the recovery unit as to whether it can deal with hydrocarbons that can create explosive mixtures with air (see also chapter 5).

Alternatively, hydrocarbons can be released into the atmosphere. Purging does not cause any severe damage due to the limited charge size (~ 200 g) of refrigerators, the lack of ozone depleting potential, and the very low GWP of 3. However, when releasing hydrocarbons, one must ensure that the oil does not run out uncontrolledly. Therefore, the venting of hydrocarbons should be done at the uppermost corner of the refrigerant circuit (i.e. the opposite of that indicated in step 8 of this chapter). When hydrocarbons are released, the maximum number of units to be processed per time depends on the size of the factory building and the ventilation system. To avoid the creation of explosive atmospheres, the formula of standard EN 378 can be considered for the sake of orientation (section 'human occupied space'). Alternatively, purging is done in an open environment.

STEPS FOR THE PROPER DISMANTLING OF REFRIGERATORS

Separating refrigerant from oil

STEP // 09



Heated oil separator heats up the refrigerant-oil mix for separation.

- Separate refrigerant from oil by using a special heated oil separator.

In special heated oil separators, the refrigerant-oil mix is heated to at least 100 °C. The degassing process normally does not take longer than a few hours. Temperature and time of degassing are interdependent, i.e. the higher the temperature, the shorter the degassing process. To ensure that all the halogenated components evaporate from the oil, the process can be done overnight. After this process, the CFC content of the waste oil should be no more than 2 g halogenated hydrocarbons/kg. The oil can then be used for co-firing energy plants (thermal utilisation) or waste oil recycling to create new oil products. Only if the concentration of halogenated hydrocarbons exceeds 2 g/kg oil, the oil must be subjected to high temperature incineration for final destruction. For the requirement of heated oil separators, please see Box 4.

The refrigerants extracted are to be deposited in special pressure vessels. The oil is stored in extra containers. Double-walled ASF containers with an additional collection tray can be used for this purpose²².

²² In Germany, these must be constructed according to DIN 30741.

STEPS FOR THE PROPER DISMANTLING OF REFRIGERATORS

Separating refrigerant from oil

STEP // 10

Display
(weight)



- Weigh the amount of refrigerants extracted in a pressure vessel.

Pressure vessel with
extracted refrigerant

STEPS FOR THE PROPER DISMANTLING OF REFRIGERATORS

Separating refrigerant from oil

STEP // 11



- Store the oil in extra containers (e.g. ASF containers).
- Containers should be double-walled with an additional collection tray.

STEPS FOR THE PROPER DISMANTLING OF REFRIGERATORS

Cutting visible parts

STEP // 12

Cut all visible protruding parts and store them separately:

- filter dryer and copper piping,
- cables.

Copper and cables are valuable components.

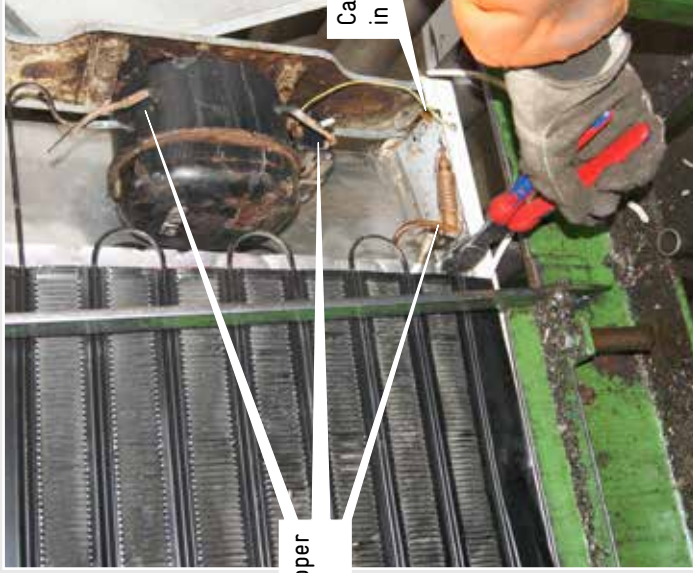

Copper

Cable (yellow in this case)



STEPS FOR THE PROPER DISMANTLING OF REFRIGERATORS

Capacitors might contain harmful substances!

STEP // 13



- Remove the capacitor from the refrigerator.
- Attention: the capacitor might contain PCB or other electrolytes of concern.
- Store the capacitor in a separate container.

STEPS FOR THE PROPER DISMANTLING OF REFRIGERATORS

Removing the compressor

STEP // 14



- Unscrew the compressor manually with a spanner.



- The compressor is a valuable component.



Spanner

STEPS FOR THE PROPER DISMANTLING OF REFRIGERATORS

Removing the compressor

STEP // 15

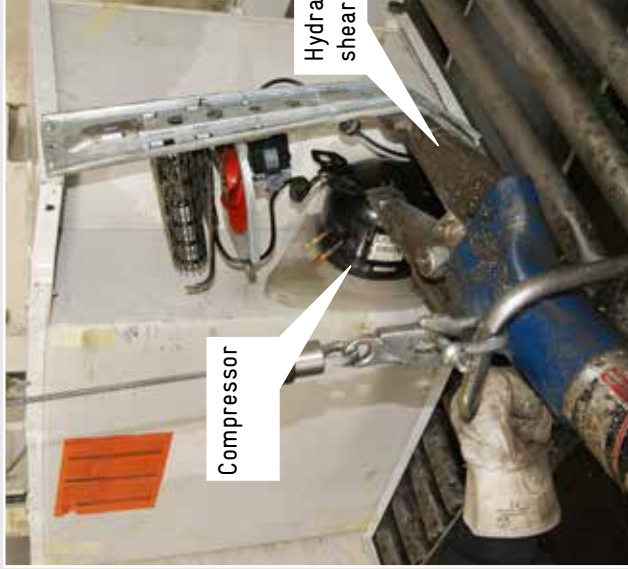

- Alternatively, use hydraulic shears to remove the compressor.

STEPS FOR THE PROPER DISMANTLING OF REFRIGERATORS

Removing the compressor

STEP // 16



- Remove the compressor from the refrigerator.

STEPS FOR THE PROPER DISMANTLING OF REFRIGERATORS

Removing the compressor

STEP // 17



- Use a drill to bore a hole into the bottom of the compressor housing.

STEPS FOR THE PROPER DISMANTLING OF REFRIGERATORS

Removing the compressor

STEP // 18



- Put the compressor upside down on an iron grating (hole pointing down) so that the remaining oil in the compressor drips down²³.
- Below the iron grating, there must be a bottom tray to capture the dripping oil.
- Compressors should only be removed from the iron grating once they have stopped dripping²³.
- Oil binders for absorbing should be available in case of spillage.

²³ Please note that the dripping oil contains up to 30% CFC (Umweltbundesamt, 1998). This is why the dripping oil should be processed in a special heated oil separator.

STEPS FOR THE PROPER DISMANTLING OF REFRIGERATORS

Removing the compressor

STEP // 19

- Put a suitable container below the bottom tray to collect the dripping oil (left).
- Ideally, the dripping oil is directly transferred to the heated oil separator (right).



STEPS FOR THE PROPER DISMANTLING OF REFRIGERATORS

Optional: further dismantling of compressor

STEP // 20

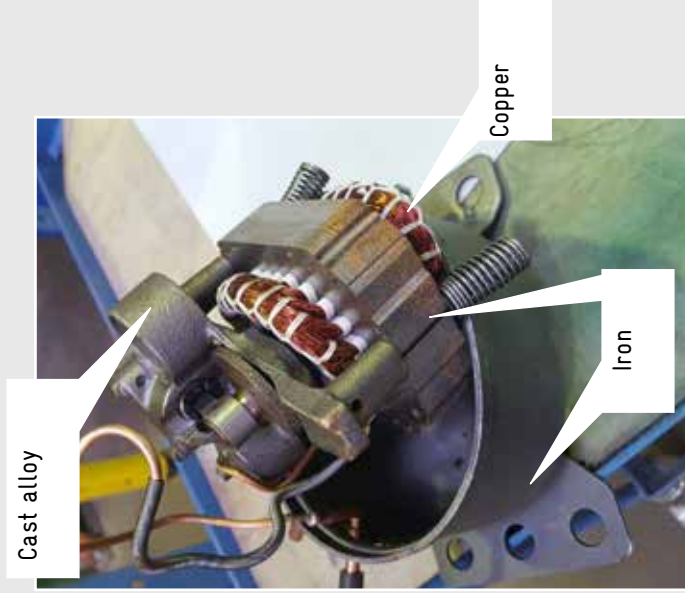

- Cut the compressor using an angle grinder.
- Separate the containing components:
 - cast alloy,
 - copper,
 - iron.
- These three components are valuable materials.

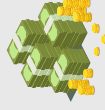

STEPS FOR THE PROPER DISMANTLING OF REFRIGERATORS

Optional: further dismantling of compressor

STEP // 21

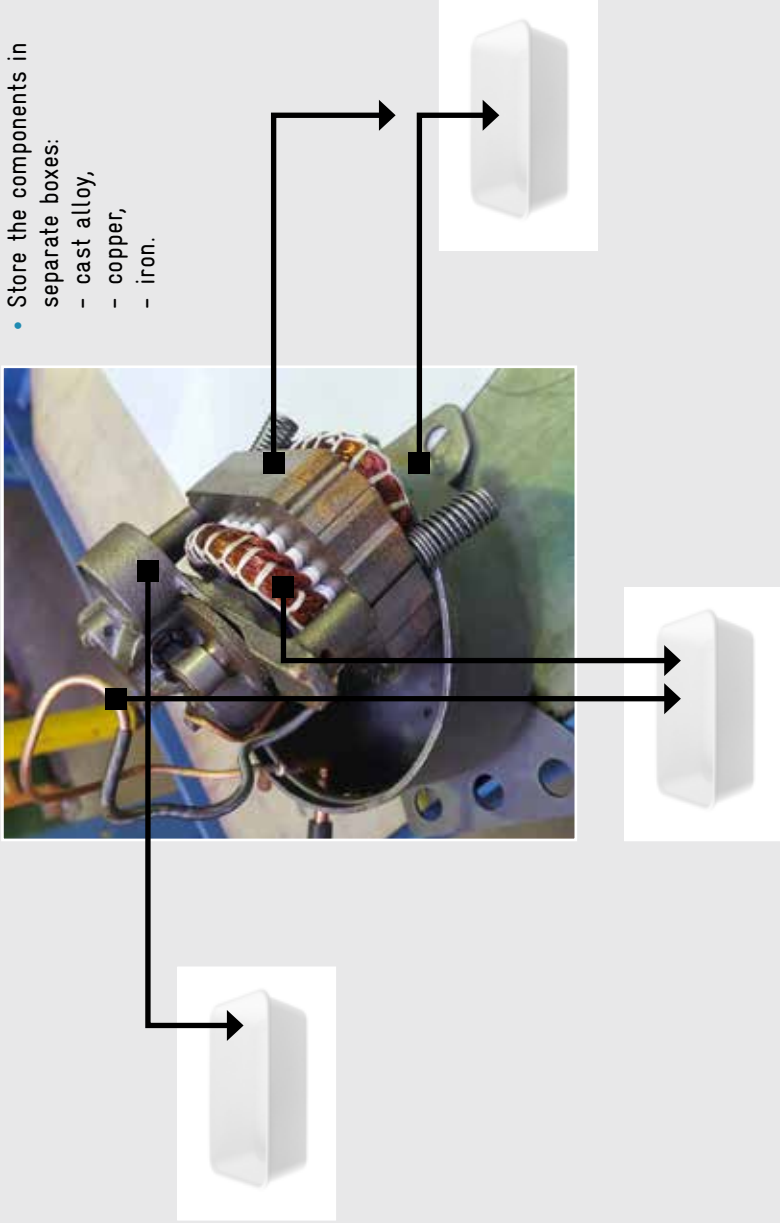

STEPS FOR THE PROPER DISMANTLING OF REFRIGERATORS

Removing the condensing unit

STEP // 22

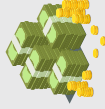

- Remove the condensing unit.
- Knock off the mounting brackets with a simple hammer.
- The condensing unit is a valuable component.



Hammer

Mounting brackets

Condensing unit

STEPS FOR THE PROPER DISMANTLING OF REFRIGERATORS

Removing the condensing unit

STEP // 23

- Remove the condensing unit.
- Store the condensing unit in a separate container.

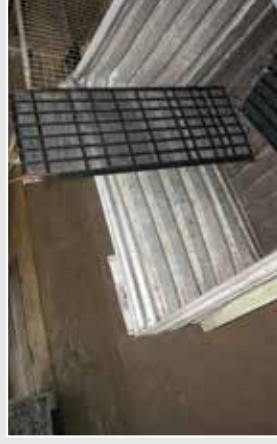

STEPS FOR THE PROPER DISMANTLING OF REFRIGERATORS

Further information on manual dismantling of foam

If stage II systems are not available (see Box 7 and Figure 19) and refrigerators cannot be burnt as entire units in high temperature incinerators approved by the Technology and Economic Assessment Panel (TEAP), manual foam stripping can be considered.



If you decide for manual dismantling of foam, ...

- remove foam in as large pieces as possible to reduce the release of blowing agents, irrespective of whether one is stripping the foam or cutting the refrigerators;
- this procedure should not take place under hot temperatures, as this greatly increases the release of blowing agents: at ambient temperatures of around 45 °C, twice the volume of blowing agents is released compared to temperatures of around 20 °C;
- use dust masks (see chapter 5.1). Additionally, mobile or stationary dust collection systems are recommended to avoid small particles from entering the lungs. The investment costs for a mobile dust collection system (Figure 20) are around EUR 180. It is important that the filter can effectively capture particles of at least 5 micron (micron is a synonym for μm and $1 \mu\text{m} = 10^{-6} \text{ m}$). Additionally, the foam stripping can be done in an open environment (only roof covering). Further information on dust limits can be found in the EU directive²⁴. The suction device can also be connected to an appropriate worktable to dismantle the foam on a ventilated table or cabinet.

24 <http://eur-lex.europa.eu/legal-content/EN/TXT/PDF/?uri=CELEX:32010L0075&from=DE>, last access 5 June 2017.

Figure 20: Mobile dust collection systems to prevent small particles from entering the lungs

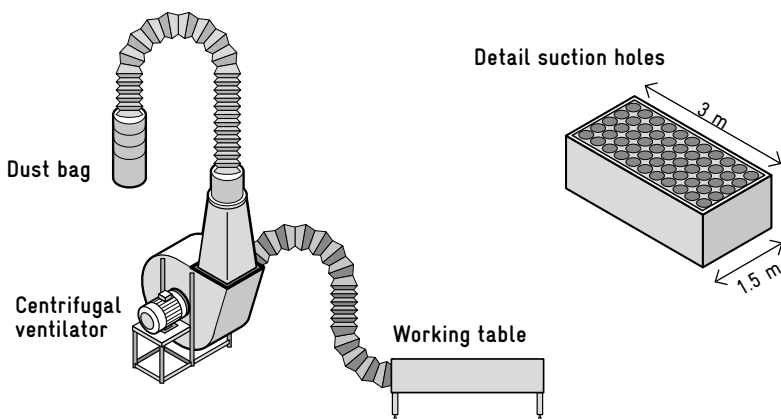

STEPS FOR THE PROPER DISMANTLING OF REFRIGERATORS

Removal of foam: foam might contain harmful substances!

STEP // 24

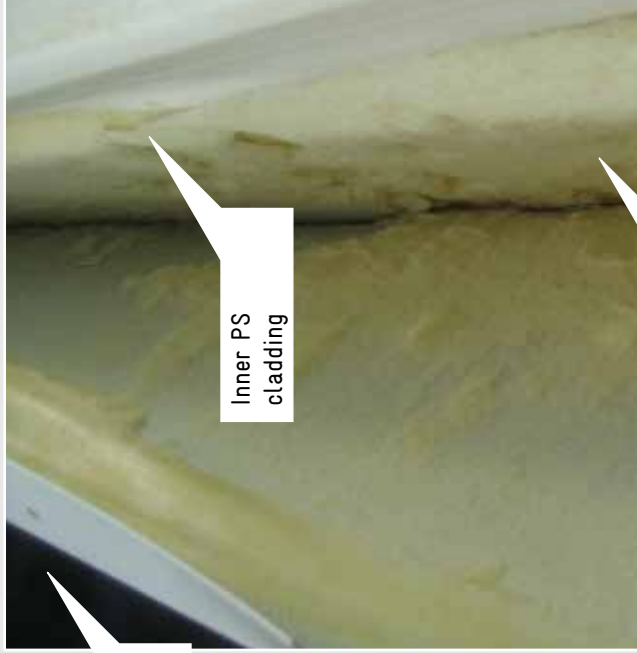

Outer metal panelling

Inner PS cladding

Foam with blowing agent

- Remove the outer metal panelling from the side walls. The seats have to be removed upfront.
- Remove the foam with a scraper, even small adhesions should be carefully scraped off.
- Remove foam in as large pieces as possible.



Scraper

STEPS FOR THE PROPER DISMANTLING OF REFRIGERATORS

Removal of foam: foam might contain harmful substances!

STEP // 25

- Store the outer metal panelling and the PS plastics in separate containers.
- Store the foam pieces in suitable bags.

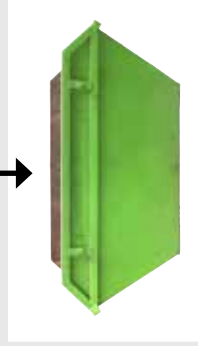
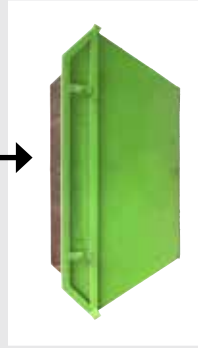
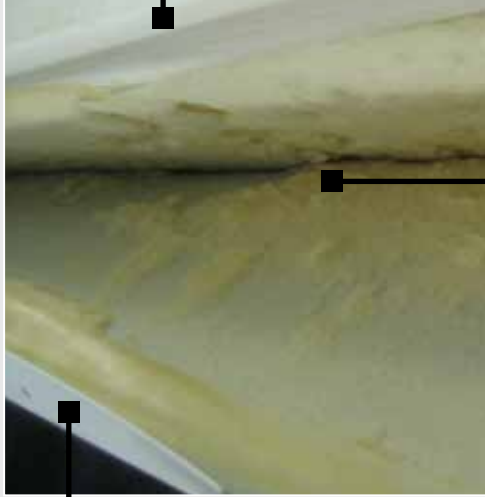

STEPS FOR THE PROPER DISMANTLING OF REFRIGERATORS

Removal of foam: foam might contain harmful substances!

STEP // 26



Angle grinder

- If refrigerators are to be cut into smaller pieces, use an angle grinder.
- Try to minimise the number of cuts to avoid the release of blowing agents.



STEPS FOR THE PROPER DISMANTLING OF REFRIGERATORS

Removal of foam: foam might contain harmful substances!

STEP // 27



STEPS FOR THE PROPER DISMANTLING OF REFRIGERATORS

Removal of foam: foam might contain harmful substances!

STEP // 28



When a refrigerator has been cut into smaller pieces:

- remove the steel enclosure from cut pieces,
- remove the interior plastic cladding (mostly PS),
- store the components in separate containers or plastic bags.

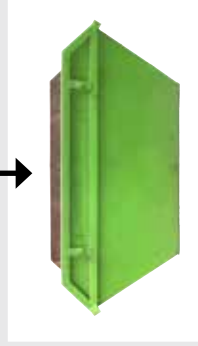
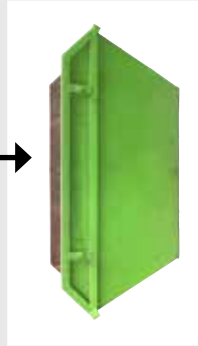

7. MANUAL DISMANTLING OF AIR CONDITIONERS

Dismantling air conditioners is less complicated than refrigerators, since no attention has to be paid to the proper recycling of foam. The following steps show the manual dismantling process of a self-contained air conditioning unit. The process is similar for other air conditioning appliance systems²⁵.

²⁵ Larger systems, such as air conditioning chillers, are (partly) dismantled at their location (on site) after the refrigerant has been properly recovered.

STEPS FOR THE PROPER DISMANTLING OF AIR CONDITIONERS

Removing outer plastic panelling

STEP // 01

What to do with the plastics?

- Remove the outer plastic panelling using a power screwdriver.
- Plastics are valuable components.

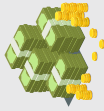

Outer plastic panelling
(white colour)

Power
screwdriver



Symbol on plastic available?

- Separate plastics according to symbols.



No symbol on plastic available?

- Store plastic parts as mixed plastics in a container for later separation.



STEPS FOR THE PROPER DISMANTLING OF AIR CONDITIONERS

Removing outer plastic panelling

STEP // 02

What to do with the plastics?

- Remove the outer plastic panelling.



Symbol on plastic available?

- Separate plastics according to symbols.

No symbol on plastic available?

- Store plastic parts as mixed plastics in a container for later separation.



STEPS FOR THE PROPER DISMANTLING OF AIR CONDITIONERS

Circuit boards might contain harmful substances!

STEP // 03



- Remove the circuit boards.
Attention: they might contain harmful substances!
- Store the circuit boards in a separate box.



Circuit board attached to plastic panelling



STEPS FOR THE PROPER DISMANTLING OF AIR CONDITIONERS

Removing compressor protection

STEP // 04



- Remove the vibration protection from the compressor.
- Put the vibration protection to mixed plastics.

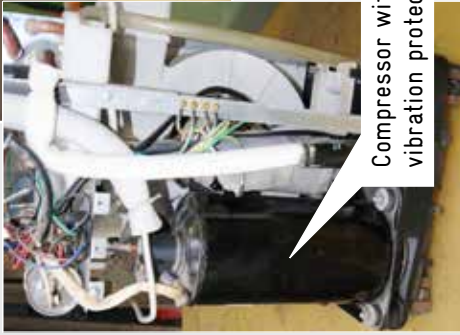

STEPS FOR THE PROPER DISMANTLING OF AIR CONDITIONERS

Refrigerants are harmful substances! Do not release into the atmosphere!

STEP // 05



- Extract the refrigerant and the oil at the lowest point.
- Please see also steps 8 to 11 from chapter 6.

STEPS FOR THE PROPER DISMANTLING OF AIR CONDITIONERS

Removing the compressor

STEP // 06



- Remove the compressor using a power screwdriver.
- The compressor is a valuable component.
- Process the compressor the same way as it was done for refrigerators.

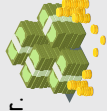

STEPS FOR THE PROPER DISMANTLING OF AIR CONDITIONERS

Removing visible parts

STEP // 07

- Cut all visible protruding parts:
 - filter dryer and copper piping,
 - cables.
- Store the components in separate boxes.

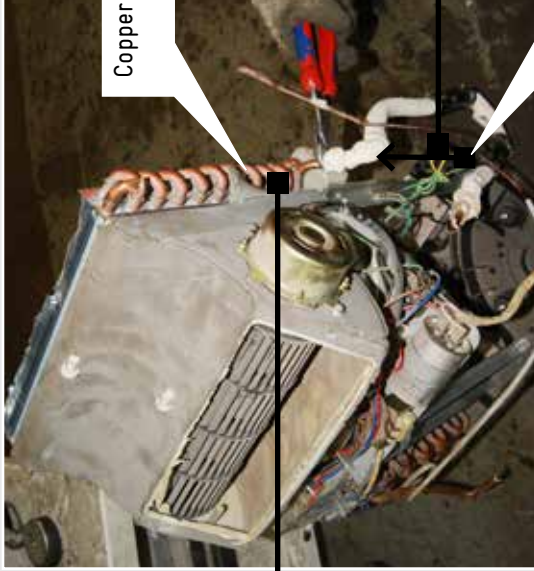

STEPS FOR THE PROPER DISMANTLING OF AIR CONDITIONERS

Removing heat exchanger

STEP // 08

- Remove the aluminium-copper heat exchanger.
- The aluminium-copper heat exchanger is a valuable component.

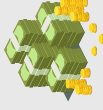

Aluminium-copper heat exchanger

Power screwdriver

STEPS FOR THE PROPER DISMANTLING OF AIR CONDITIONERS

Removing heat exchanger

STEP // 09

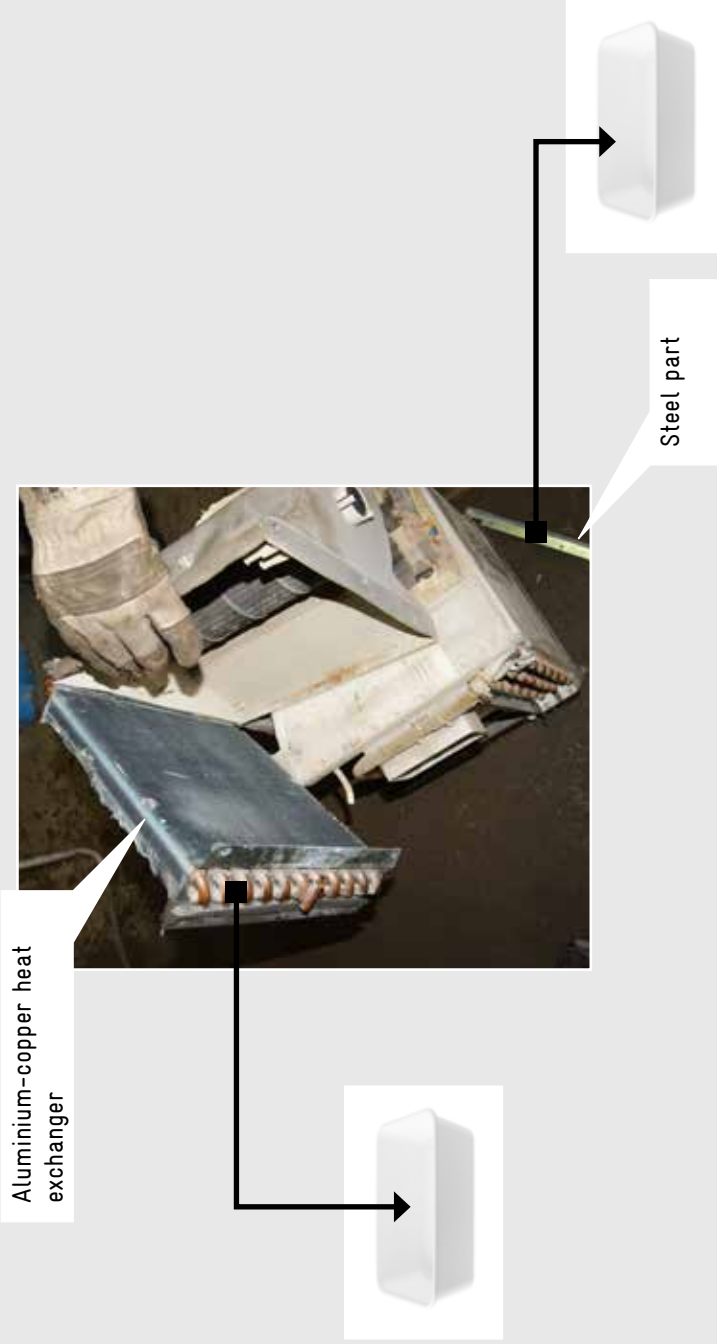

STEPS FOR THE PROPER DISMANTLING OF AIR CONDITIONERS

Removing fan and e-motor

STEP // 10

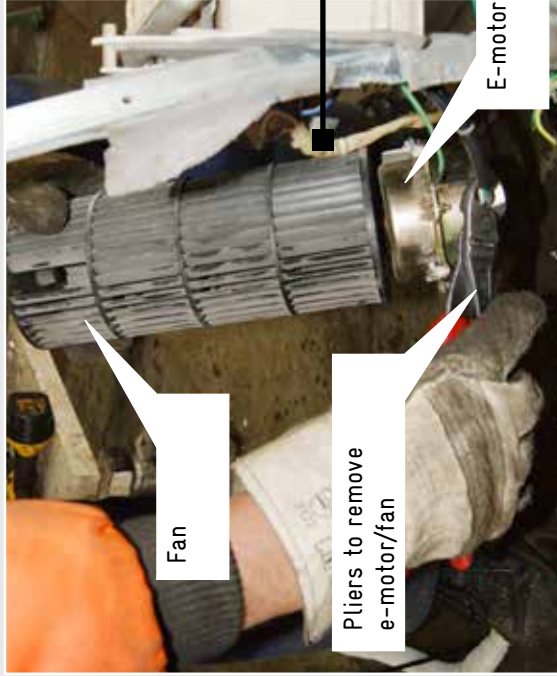

- Remove the fan and the e-motor using pliers.
- The e-motor is a valuable component.
- Store the e-motor and fan in a separate box.

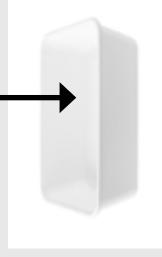

STEPS FOR THE PROPER DISMANTLING OF AIR CONDITIONERS

Circuit boards might contain harmful substances!

STEP // 11

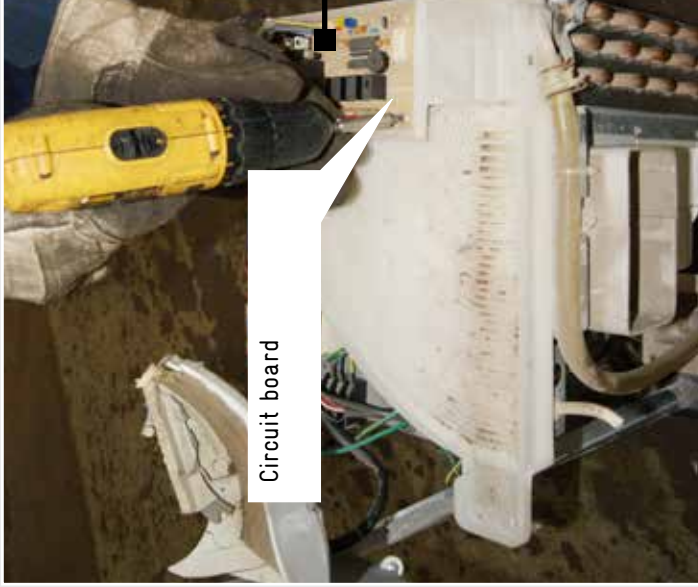

- Remove other visible circuit boards.
- Attention: circuit boards might contain harmful substances!
- Store the circuit boards in a separate box.

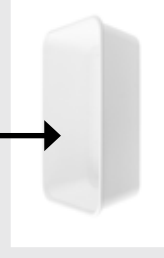

STEPS FOR THE PROPER DISMANTLING OF AIR CONDITIONERS

Removing cables

STEP // 12



- Remove all visible cables.
- Cables are valuable components.
- Store cables in a separate box.



Cables

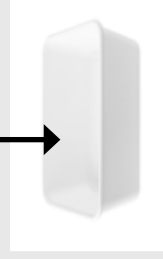

STEPS FOR THE PROPER DISMANTLING OF AIR CONDITIONERS

Capacitors might contain harmful substances!

STEP // 13



Capacitor

- Remove the capacitor.
- Attention: capacitors might contain harmful substances!
- Store the capacitor in a separate box.

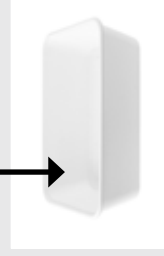

STEPS FOR THE PROPER DISMANTLING OF AIR CONDITIONERS

Removing transformer

STEP // 14



- Remove the transformer.
- Store the transformer in a separate box.
- Transformers are valuable components.

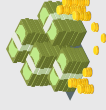

Finally, Figure 21 shows the extracted components from the dismantling process of a self-contained air conditioner.

Figure 21: Extracted components from a self-contained air conditioning unit

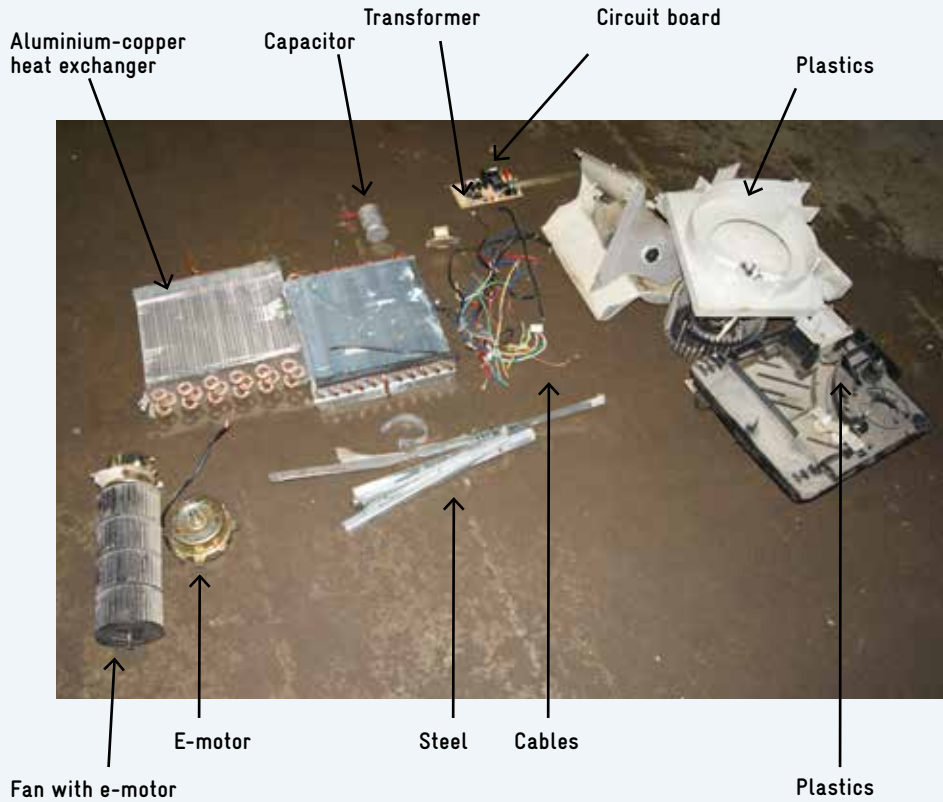

8. PROCESSING AND VALORISATION OF EXTRACTED MATERIALS

8.1 Further processing and separation of extracted components

The recovered components should separately be sorted and stored in appropriate containers and boxes. The suggested categories for recovered components were presented in chapter 4 (Figure 9 and Figure 21).

The greatest advantage of manual dismantling, assuming sufficient manpower is available, is the high degree to which plastics and metals can be separated. The more homogeneously the materials are sorted, the higher the selling price on the recycling market.

With some experience, metals can well be distinguished:

- steel,
- aluminium,
- copper.

Plastics can further be separated into:

- polystyrene (PS),
- polypropylene (PP),
- acrylonitrile butadiene styrene (ABS).

However, the visual separation of plastics is more difficult. Sometimes the abbreviations (e.g. PP) are given somewhere on the plastic part, but very often such a label is missing. If this is the case, special detectors can be used for the identification of different plastic types and the presence of flame-retardants (investment costs > EUR 6,000). These detectors rely on X-ray fluorescence, near infrared reflectance spectroscopy (NIRS) or sliding spark spectrometer (SSS), and are portable. Examples are:

- portable unit RFA NITON XL2,
- NIR Bruker Vektor 22/N,
- mIRoGun 2.0, SSS-3-FR.

There is also a simpler approach: the burn test. This method relies on three characteristics when pieces of plastics are burnt: type of flame, smoke and odour. Each plastic shows typical characteristics for these three parameters. However, as this method might cause a health risk when the fume is inhaled, we do not recommend using the burn test.

Even PCB-free capacitors might be dismantled further. However, as this is a critical task and requires specialised know-how, we do not recommend this separation and suggest to treat all capacitors as hazardous waste.

8.2 Final disposal

The following extracted components are subject to disposal:

- capacitors,
- ammonia solution containing chromium-VI (used as refrigerant),
- CFCs and other critical refrigerants and blowing agents.

8.3 Recycling options of recovered materials

Table 5 provides an overview of the different recycling options for the materials that are recovered during manual dismantling of refrigerators and air conditioners. Generally, these recycling processes are not done by the WEEE management companies, but components are sent to special treatment facilities.

Table 5: Recycling options of recovered materials

COMPONENTS	RECYCLING OPTIONS
Aluminium sheets	Smelting
Iron	Smelting
PS granulate	Mechanical recycling
Glass	Smelting
Compressor	Smelting after separation of components
Aluminium-copper heat exchanger	Crushing, separation and smelting
E-motors	Crushing, separation and smelting
Cables without plug	Separation in cable recycling plant
Cables with plug	Separation in cable recycling plant
Aluminium cast	Smelting
Stainless steel	Smelting
Capacitor	Final disposal or first separation and then smelting
Hg switches	Recovery of mercury in special plants (rest: glass)
Plastics	Mechanical recycling, feedstock recycling, energy recovery
Refrigerant	Final disposal or reclaim
Ammonia	Final disposal
PUR	<ul style="list-style-type: none"> • Final disposal when PUR contains harmful blowing agent • Degassed PUR to be used as oil binding material • Crushed degassed PUR to be used in cement kilns (co-firing)

8.4 Recycling of plastics

Plastics can be recycled mechanically, feedstock-recycled or used for energy recovery.

Mechanical recycling is the most recommended recycling technique²⁶. It requires correctly sorted plastics. Afterwards, the plastic is ground or crushed, washed and cleaned of unwanted substances such as paper and metals. The plastics are heated to become flexible and to form new shapes. Possible products are toolboxes, jewel cases, dustbins, floor plates, window frames and palisades.

In feedstock recycling, the macromolecules of the plastic waste are broken down to low-molecular compounds (methanol or mixtures such as synthesis gas and oils). The petrochemical feedstock derived is used in refineries and chemical plants to produce new products.

The energetic use of plastics in large-scale industrial applications (waste to energy) is only recommended when the plastics contain flame retardants. By using combined heat and power systems, both district heating and electricity can be generated.

8.5 The value of extracted components

Table 6 shows a qualitative assessment (traffic light scheme) of the net material value of extracted components on the recycling market. Red colouring indicates negative costs (where WEEE managers have to pay for further processing), yellow colouring indicates net values of up to EUR 300 per ton, while green colouring shows valuable components with net values up to EUR 1,500 per ton²⁷. We refrained from showing absolute values as the prices are subject to high temporal changes and differ depending on the region, demand and oil price. Still, relative levels normally remain constant, thus the table indicates which components achieve high prices on the recycling market and those with negative costs.

²⁶ <http://www.bvse.de/index.php>, last access 5 June 2017.

²⁷ Values for the German recycling market in February 2016: personal communication Georg Wallek, Managing Director (COO Recycling centre ESO GmbH in Offenbach).

Table 6: Qualitative assessment (traffic light scheme) of the net material values of extracted components on the recycling market²⁸

COMPONENTS	AIR CONDITIONER	REFRIGERATOR
Aluminium sheets		Panelling of the freezing compartment
Iron	Little pieces for cover panels	Condensing unit, outer panelling
PS granulate	Not available without crushing technique	Not available without crushing technique
Glass		Shelves
Compressor	X	X
Aluminium-copper heat exchanger	X	
Electro motors	X	
Cables without plug	X	X
Cables with plug	X	X
Aluminium cast	Part of compressor	Part of compressor
Stainless steel		Little parts in commercial refrigerators
Capacitor	X	X
Transformer	X	
Refrigerant	X	X
Mixed plastics	X	X

28 Personal communication Georg Wallek, Managing Director (COO Recycling centre ESO GmbH in Offenbach).

The **most valuable components are aluminium-copper heat exchangers and cables without plugs**. Therefore, we recommend cutting the plugs from the plug-in power supply if sufficient human resources are available. Remaining plugs can then be sold for approximately EUR 40 to 50 per ton on the recycling market.

Compressors achieve higher prices (approximately EUR 400 per ton) when cut and disassembled into individual components. Whether this is economically feasible, strongly depends on local salaries and raw material prices. The higher the price for copper and aluminium, the more attractive the disassembly of compressors.

Glass does not achieve returns. In Germany, the same holds true for ODS, mixed plastics and capacitors.

Plastics can achieve high returns, too, when sorted properly. In particular, ABS is a highly valuable plastic type²⁹.

Generally, higher prices are paid for granulate because the mechanical crushing leads to higher purity. Granulate is derived by crushing and separation techniques (see chapter 9). Iron granulate, for example, fetches EUR 250 per ton, while normal extracted iron will fetch around EUR 120 per ton³⁰. On the other hand, crushing and separation technologies are costly investments with considerable operational costs. It is essential to have a business plan that justifies such investments (see also chapter 9).

Balancing the returns and costs for proper waste management of components containing hazardous substances **will give the net value of the appliance**. An important finding is that this balancing is positive for both refrigerators and air conditioners. That is, even accounting for the proper management of certain critical components (hazardous waste), **the revenue from both appliances is between EUR 5 and 15 per appliance** in developed and developing countries. The returns on air conditioners are always slightly higher (around EUR 3 per appliance, but still within the range) due to the valuable aluminium-copper heat exchanger and the lack of PUR, with its costly blowing agent treatment.

²⁹ Current exchange prices for different plastics can be followed at http://plasticker.de/preise/preise_monat_multi_en.php, last access 5 June 2017.

³⁰ Values for the German recycling market in February 2016: personal communication Georg Wallek, Managing Director (COO Recycling centre ESO GmbH in Offenbach).

9. CHECKLIST AND OUTLOOK

The following table (Table 7) is a checklist for WEEE management companies and their employees, summarising the most important aspects to consider for manual dismantling of refrigerators and air conditioners.

Table 7: Checklist for WEEE management companies and employees for successful manual dismantling of refrigerators and air conditioners

Are all relevant environmental licences available?	✓
Are all the necessary pieces of equipment and tools in place at the WEEE management company?	✓
Are the employees adequately equipped regarding job safety and trained to handle components containing hazardous waste?	✓
Were all hazardous components removed from the appliances? <ul style="list-style-type: none">• Refrigerant and foam parts with the blowing agent• Mercury (only chest freezers)• Printed circuit boards components (in air conditioners and refrigerators)• PCB in capacitors (refrigerators and air conditioners)• PBB and PBDE in plastics as flame retardants (higher probability to find these substances in air conditioners than in refrigerators)	✓
Do I have a market for all valuable recovered components?	✓

We recommend that WEEE managers get in contact with other WEEE management companies to learn and exchange practices and knowledge about technology and markets. WEEE managers often store components since they do not see possibilities to sell them on the market. **Networks and consortia are also important** to increase the amount of components recovered, thereby improving export opportunities.

Towards stage II

From an environmental perspective, it is **recommended to use stage II systems** where the foam is crushed in encapsulated systems with recovery of the blowing agent (see also Box 3). However, transitional options appear reasonable while the waste stream of refrigerators is still low³¹, which again depends on the effectiveness of the WEEE collection scheme.

³¹ As a rule of thumb, around 100,000 refrigerators should be available to justify a stage II system.

Once the manual dismantling of refrigerators and air conditioners within stage I is established, the key question of many countries is: what to do with the PUR? The following paragraph offers some solutions while simultaneously indicating successive upgrades towards stage II systems.

The foam should be milled in a crushing machine with subsequent recovery of the blowing agents. For the crushing process we recommend 'Querstromzerspaner', a chain impactor which can later be used for whole refrigerators and other small WEEE after appropriate upgrades. The principle of 'Querstromzerspaner' consists of rotating chains that launch the material to be crushed. These launched particles are milled when colliding with each other³². The process must be done in an inert atmosphere (injection of N₂ gas) to avoid the creation of explosive atmospheres and in a decompressed environment to recapture the blowing agents which are released through the grinding. The process air is withdrawn by suction from the crushing machine, passing filters for purification from particles. Afterwards, there are various options to recover the blowing agent from the process air:

- 1) **Cryocondensation:** The escaped blowing agents are liquefied by cooling down the process air, using liquid nitrogen. Even in countries with high refrigerator waste streams, this option is increasingly less applied, due to the complexity of this technology and high operational costs (about EUR 300 per day for liquid nitrogen and considerable energy costs).
- 2) **Activated carbon – incineration:** Water and humidity is recovered from the process air and the stream is passed over extruded activated carbon. Once the filter is 'full', the activated carbon is replaced. The adsorption process is exothermic, so that desorption requires a heat source. Further safety requirements are necessary if the foams collected contain both CFC-11 and cyclopentane blowing agents (or only cyclopentane). To identify the blowing agents, special detectors (around EUR 4,000) can be used, which are inserted into the foam for this purpose. In case cyclopentane had been used, additional inertia must be created during this process. Also, the storage and transport requires further safety measures. The activated carbon filter can be disposed of as a whole in a hazardous waste incinerator (possibly also cement kilns)³³.
- 3) **Activated carbon – reusable:** This option is increasingly applied. The process is similar to that described under option 2; however, the gases are desorbed, mainly by using water. After the desorption process, the activated carbon can be reused. Neutralisation is an issue that has to be considered under this option.

32 'Querstromzerspaner' are available in different sizes (diameter of chamber): 1,200 mm, 1,600 mm, 2,000 mm and 2,500 mm.

33 A desorption process in an air-tight chamber also might be possible to reuse activated carbon; however, there is no experience with this option so far.

Besides the foam, entire refrigerators and small WEEE can be processed in the crushing machine at a later stage. For this, additional components are necessary:

- airflow separator (filter, cyclones),
- overbelt magnet,
- conveyor belt.

After the crushing process, the grinding stock is transported via conveyor belts to an airflow separator. Here, small and slight particles (PS and PUR) are separated, later metals are extracted from the grinding stock with overbelt magnets. Aluminium-copper parts are the remaining fraction. The great advantage of this separation process is the high quality of the granulate, which generally fetches higher prices on the recycling market.

BOX 7

STAGE I, II AND III FOR REFRIGERATORS

Stage I: This includes removal of loose parts, extraction of refrigerant and oil, separating oil from refrigerant, removing hazardous components, removing the compressor including attached components (and draining the compressor from oil) and the condensing unit (see also chapter 6).

Stage II: Crushing process in an encapsulated system with the recovery of the blowing agents. Before the appliances are subject to stage II, they necessarily have to go through the steps mentioned previously under stage I. During the mechanical processing of the foam in stage II, between 70 and 80% of the blowing agents are released which are then recaptured using appropriate techniques (e.g. liquefying in cooling trap or pressure, and active coal). The remaining 20 to 30% of blowing agents are extracted from the foam matrix by vacuum or temperature application. The recovered blowing agents must be stored in adequate cylinders. These stage II systems are relatively expensive with investment costs between EUR 2 and 4 million.

Stage III: Recently, sophisticated stage III systems have been introduced, where final destruction of ODS takes place within stage II systems. Different techniques and options are possible. Liquefied or gaseous refrigerants and blowing agents are destroyed by thermal or catalytic treatment.

10. REFERENCES

Australian Department of the Environment, 2014. End-of-Life Domestic Refrigeration and Air Conditioning Equipment in Australia.

GIZ, 2013. Best Practice Guidebook for SMALL South African E-Waste Businesses.

GIZ, 2014. Green Cooling Technologies - Market trends in selected refrigeration and air conditioning subsectors.

GIZ, 2017. Guideline to establish a collection system for equipment containing ODS.

IGES, 2009. Environmental and Human Health Risks Associated with the End-of-Life Treatment of Electrical and Electronic Equipment. Institute for Global Environmental Strategies. <https://www.ecotic.ro/wp-content/uploads/2015/07/7b0720b8b07623e752380504460d5ec1edf51e85.pdf>, last access 5 June 2017.

LAGA 31, 2009. Mitteilung der Bund/Länder-Arbeitsgemeinschaft Abfall (LAGA) 31. Anforderungen zur Entsorgung von Elektro- und Elektronik-Altgeräten.

Ministerio de Ambiente, Vivienda y Desarrollo Territorial, Colombia, 2010. Lineamientos Técnicos para el Manejo de Residuos de Aparatos Eléctricos y Electrónicos.

Öko-Institut e.V., 2007. Ökobilanzielle Untersuchung zur Verwertung von FCKW- und KW-haltigen Kühlgeräten.

Öko-Institut e.V., 2010. Study of the ozone depletion and global warming potentials associated with fridge recycling operations that involve the manual stripping of polyurethane insulation foam. RAL-Gütegemeinschaft Rückproduktion von Kühlgeräten e.V.

Ongondo F.O., Williams I.D., Cherrett T.J., 2010. How are WEEE doing? A global review of the management of electrical and electronic wastes. *Waste Management* 31 (2011), 714-730.

RAL 728, 2007. Rückproduktion von Kühlgeräten. Quality Assurance and Test Specifications for the Demanufacture of Refrigeration Equipment. Gütesicherung RAL-GZ 728. Sankt Augustin, Germany.

RMIT, 2006. A Literature Review on the Environmental and Health Impacts of Waste Electrical and Electronic Equipment. RMIT University Melbourne, Australia.

Umweltbundesamt, 1998. Leitfaden zur Entsorgung von Kühlgeräten, Berlin, Germany.

United Nations Environment Programme, 2013. Metal Recycling: Opportunities, Limits, Infrastructure. Available at:
https://wedocs.unep.org/bitstream/handle/20.500.11822/8423/-Metal%20Recycling%20Opportunities,%20Limits,%20Infrastructure-2013Metal_recycling.pdf?sequence=3&isAllowed=y,
last access 18 April 2017.

UNEP RTOC, 2015. UNEP 2014 Report of the Refrigeration, Air Conditioning and Heat Pumps Technical Options Committee: 2014 Assessment. UNEP, Nairobi, Kenya. Available at:
<http://conf.montreal-protocol.org/meeting/mop/mop-27/presession/Background%20Documents%20are%20available%20in%20English%20only/RTOC-Assessment-Report-2014.pdf>,
last access 1 February 2017.



Deutsche Gesellschaft für
Internationale Zusammenarbeit (GIZ) GmbH

Registered offices
Bonn and Eschborn, Germany

Friedrich-Ebert-Allee 36 + 40
53113 Bonn, Germany
T +49 228 44 60-0
F +49 228 44 60-17 66

Dag-Hammarskjöld-Weg 1 - 5
65760 Eschborn, Germany
T +49 61 96 79-0
F +49 61 96 79-11 15

E info@giz.de
I www.giz.de