



# Technical principles and framework conditions for the recycling of e-waste thermoplastics

---

On behalf of the Environmentally Sound Disposal and Recycling of Electronic Waste Programme (E-Waste Programme)

BERND BUNGERT, DECEMBER 2022

---

As a federally owned enterprise, GIZ supports the German Government in achieving its objectives in the field of international cooperation for sustainable development.

**Published by:**

Deutsche Gesellschaft für  
Internationale Zusammenarbeit (GIZ) GmbH  
Registered offices  
Bonn and Eschborn

GIZ Country Office Accra  
7 Volta Street | Airport Residential Area  
P.O. Box KIA 9698  
Accra | Ghana  
F +233 302 760 448  
E [giz-ghana@giz.de](mailto:giz-ghana@giz.de)  
I [www.giz.de/ghana](http://www.giz.de/ghana)  
I [www.giz.de](http://www.giz.de)

**Programme/project description:**

Environmentally Sound Disposal and Recycling of E-Waste in Ghana (E-Waste Programme)  
Airport Residential Area  
Accra – Ghana  
Head of Programme: Markus Spitzbart  
<https://www.giz.de/en/worldwide/63039.html>

**Author:**

Prof. Dr.-Ing. Bernd Bungert, Berlin University of Applied Science (BHT), Accra Ghana; Berlin, Germany



**Editor:**

Bernd Bungert

**Design/layout, etc.:**

Bernd Bungert

**Photo credits/sources:**

Main text: Source given next to image  
Cover Pager: GIZ/ E-Waste Programme

**URL links:**

This publication contains links to external websites. Responsibility for the content of the listed external sites always lies with their respective publishers. When the links to these sites were first posted, GIZ checked the third-party content to establish whether it could give rise to civil or criminal liability. However, the constant review of the links to external sites cannot reasonably be expected without concrete indication of a violation of rights. If GIZ itself becomes aware or is notified by a third party that an external site it has provided a link to gives rise to civil or criminal liability, it will remove the link to this site immediately. GIZ expressly dissociates itself from such content.

**Maps:**

The maps printed here are intended only for information purposes and in no way constitute recognition under international law of boundaries and territories. GIZ accepts no responsibility for these maps being entirely up to date, correct or complete. All liability for any damage, direct or indirect, resulting from their use is excluded.

On behalf of  
German Federal Ministry for Economic Cooperation and Development (BMZ)  
Division 203 West Africa II  
Contact person at the ministry: Dr. Friederike Fuhlrott  
Bonn

GIZ is responsible for the content of this publication.

Accra, December 2022

## Table of Contents

<b>List of Figures</b>	<b>6</b>
<b>List of Tables</b>	<b>8</b>
<b>1. Introduction, goal of this study</b>	<b>10</b>
1.1. Targets of the KfW, GIZ e-waste programme	10
1.2. Aim of this compendium	11
<b>2. Stakeholder analysis plastics sector and legal framework</b>	<b>12</b>
2.1. Practical actors	12
2.1.1. Formal recycling companies	12
2.1.2. Plastics processors	13
2.2. Summary of relevant laws and regulations	14
2.2.1. International	14
2.2.2. National	16
2.3. Pilot incentive system implemented by MESTI-PIU in cooperation with KfW	17
<b>3. Basics of plastics: types, properties, processing</b>	<b>19</b>
3.1. Plastics and polymer basics	19
3.2. Plastics processing	25
3.3. Plastics additivation	28
3.4. Material properties and material testing	29
<b>4. Technical principles of plastics recycling</b>	<b>34</b>
4.1. Obstacles for high-value recycling	34
4.1.1. Particles	34
4.1.2. Colour	34
4.1.3. Odour	35
4.1.4. Incompatibility	35
4.1.5. Degradation during use	36
4.1.6. Mixing of grades of polymers	36
4.2. Mechanical processing	37
4.3. Sorting	37
4.3.1. Hand sorting by application	38
4.3.2. Hand sorting with solvents	40
4.4. Float-Sink separation	41

<b>4.5.</b>	<b>Washing and label removal</b>	<b>42</b>
<b>4.6.</b>	<b>Drying</b>	<b>42</b>
<b>4.7.</b>	<b>Extrusion</b>	<b>42</b>
<b>4.8.</b>	<b>Environmental impacts</b>	<b>43</b>
4.8.1.	Leaching and migration of additives (e.g. brominated flame retardants)	43
4.8.2.	Byproducts from incineration or burning	43
<b>4.9.</b>	<b>Handling of material that cannot be recycled</b>	<b>43</b>
4.9.1.	Landfill	43
4.9.2.	Incineration facilities (Takoradi, Municipal oven facilities (hospitals))	43
4.9.3.	Steel works and cement industry	44
<b>5.</b>	<b>WEEE plastics and value chain for recycling</b>	<b>45</b>
<b>5.1.</b>	<b>WEEE plastics in Ghana</b>	<b>45</b>
5.1.1.	Types and applications in WEEE	45
<b>5.2.</b>	<b>Recycling value chain</b>	<b>46</b>
5.2.1.	WEEE plastics and post-consumer plastics	46
5.2.2.	Value chain by technologies	50
<b>5.3.</b>	<b>GIZ Pilot facility and properties of WEEE recyclates</b>	<b>53</b>
5.3.1.	Pilot facility at TTC	53
5.3.2.	Pilot runs on ABS and HIPS	54
5.3.3.	Material properties of ABS and HIPS recyclates	57
<b>5.4.</b>	<b>Guidelines for Handover Center and collectors</b>	<b>62</b>
<b>6.</b>	<b>Applications of recycled WEEE plastics and economical feasibility</b>	<b>68</b>
<b>6.1.</b>	<b>Price and application of virgin material</b>	<b>68</b>
<b>6.2.</b>	<b>Business case 1: Collection, identification and flake production of ABS by aggregator</b>	<b>69</b>
6.2.1.	General Description and Specific Characteristics	69
6.2.2.	Recommended Recycling Options	69
6.2.3.	Resulting Material Flow	70
6.2.4.	Economic Framework	70
6.2.5.	Employment opportunities	70
<b>6.3.</b>	<b>Business case 2: Depolluted (BFR-free and Polyolefin-free) ABS flakes</b>	<b>71</b>
6.3.1.	General Description and Specific Characteristics	71
6.3.2.	Resulting Material Flow	73
6.3.3.	Economic Framework	74
6.3.4.	Employment opportunities	74

<b>6.4.</b>	<b>Business case 3: Extrusion of flakes, pelletization</b>	<b>75</b>
6.4.1.	General Description and Specific Characteristics	75
6.4.2.	Resulting Material Flow	75
6.4.3.	Economic Framework	75
<b>6.5.</b>	<b>Business case 4: Export of depolluted ABS flakes to Europe</b>	<b>76</b>
<b>6.6.</b>	<b>Business case 5: Export of depolluted ABS flakes to West African countries</b>	<b>76</b>
<b>6.7.</b>	<b>Business case 6: Other applications</b>	<b>76</b>
<b>7.</b>	<b>Impact analysis</b>	<b>79</b>
7.1.	Social	79
7.2.	Economic	79
7.3.	Environmental	79
7.4.	Contribution to the goals of the GIZ e-waste programme	80
	<b>List of References</b>	<b>81</b>

## List of Figures

Figure 2-1:	EPA WEEE collection system	18
Figure 3-1:	What is a polymer?	19
Figure 3-2:	Most commonly used polymers by production, their common name in Ghana and polymers used in WEEE plastics	20
Figure 3-3:	Most common plastics by use	21
Figure 3-4:	Worldwide plastics production of 400 million tonnes = 1 billion m <sup>3</sup> : order of magnitude	21
Figure 3-5:	Microstructure of polymers	22
Figure 3-6:	Price, performance and production volumes of various polymers	23
Figure 3-7:	What is a plastic?	24
Figure 3-8:	Processing method 1: extrusion, compounding, pelletization	26
Figure 3-9:	Processing method 2: injection moulding	26
Figure 3-10:	Processing method 4: blow moulding	27
Figure 3-11:	Processing method 7: vacuum forming based on sheets	27
Figure 3-12:	Processing method 8: rotational moulding	28
Figure 3-13:	Experimental setup to determine MFI (MFR, MVR)	30
Figure 3-14:	Test bars for tensile test to obtain stress-strain curve (measures in millimeters)	31
Figure 3-15:	Equipment for tensile test to obtain stress-strain curve	31
Figure 3-16:	Stress-strain curve obtained from tensile test	32
Figure 3-17:	Measuring principle for determination of impact strength	32
Figure 4-1:	Incompatibility of different plastics& polymers	36
Figure 4-2:	Sorting according to type, application and colour	37
Figure 4-3:	Sorting according to label: complete labelling of a plastic type	37
Figure 4-4:	Sorting according to label: labels and typical labelling on back of appliance	38
Figure 4-5:	Most common items in WEEE and the main plastics component	39
Figure 4-6:	Hand sorting with the procedure proposed by SRI [Bill 2019]	40
Figure 4-7:	Hand sorting with the limonene test: HIPS becomes sticky	40
Figure 4-8:	Sorting with the float-sink method, removal of BFRs	41
Figure 4-9:	Density adjustment of salt solution for float-sink separation	41
Figure 4-10:	Salt for density adjustment can be bought on the market (March 2022: one sack with 100 kg = GHS 110.-)	42
Figure 4-11:	Incineration facility in Vume, Volta region (left), uncontrolled burning on the former scrapyards of Agbogbloshie	44
Figure 5-1:	Composition of WEEE plastics sampled at mgg-polymers	46
Figure 5-2:	Material flow of Electrical and Electronic Equipment (EEE) and Waste EEE (WEEE) in Ghana	47
Figure 5-3:	Material flow of Consumer Plastics and Post Consumer Plastics in Ghana	47
Figure 5-4:	Post Consumer Plastics Recycling in Ghana: overview of value chain	48



Figure 5-5:	Post Consumer Plastics Recycling in Ghana: value chain	48
Figure 5-6:	Collection of “hard plastics”, piling of “non-usable plastics” and burning	49
Figure 5-7:	WEEE plastics collected during recycling of post consumer plastics are being burned	50
Figure 5-8:	Value chain for recycling of WEEE plastics: hand sorting (“manual route”)	50
Figure 5-9:	Value chain for recycling of WEEE plastics: technical version (“machine route”)	51
Figure 5-10:	WEEE plastics recycling: “machine route” with electrostatic separation	51
Figure 5-11:	“Machine route”: state of the art WEEE plastics recycling plant	52
Figure 5-12:	Float-Sink basins at TTC made from used Intermediate Bulk Containers (IBCs)	53
Figure 5-13:	Float-Sink basins at TTC	53
Figure 5-14:	Drying of recyclates on plastic film in the open air	54
Figure 5-15:	Shredding and sieving of HIPS at the “plastics hotspot”	55
Figure 5-16:	Collection, sorting, shredding of ABS flatscreens	56
Figure 5-17:	ABS flakes sample ABS 001	57
Figure 5-18:	ABS flakes sample ABS 002	58
Figure 5-19:	HIPS flakes sample HIPS 001	58
Figure 5-20:	Tensile bars made by injection moulding at TITK for ABS 001	60
Figure 5-21:	Collection of WEEE plastics at MESTI-PIU	62
Figure 5-22:	Analysis of WEEE plastics sample from MESTI-PIU	63
Figure 5-23:	Sample of WEEE plastics	63
Figure 5-24:	Sorting according to application	64
Figure 5-25:	Collection model implemented by MESTI-PIU (collection method I)	64
Figure 5-26:	Possible methods of collection I, II	65
Figure 5-27:	Possible methods of collection III	65
Figure 5-28:	Possible scenario in collection system	66
Figure 5-29:	Collection of post-consumer plastics together with WEEE plastics: necessary capacity building	66
Figure 5-30:	Train the trainer session on WEEE plastics recycling	67
Figure 6-1:	Price and performance of plastics	68
Figure 6-2:	Collection, identification and flake production by aggregator	69
Figure 6-3:	To feed one facility for depolluted ABS and HIPS 5 collectors/ aggregators are needed	71
Figure 6-4:	Process flow for depolluted ABS/ HIPS	72
Figure 6-5:	Material flow for depolluted ABS/ HIPS	73
Figure 6-7:	Drain-waste-vent	77

## List of Tables

Table 2-1:	Formal recycling companies according to the EPA audits from 2020	12
Table 3-1:	Most commonly used polymers by production	20
Table 3-2:	Plastics-processing methods	25
Table 3-3:	Plastic additives, their use and global production share	29
Table 5-1:	Plastic types and current status of collection and recycling	49
Table 5-2:	Composition and particle-size distribution sample ABS 001	59
Table 5-3:	Composition and particle-size distribution sample HIPS 001	59
Table 5-4:	Material properties of recyclates, commercial recyclates and virgin material	60
Table 5-5:	Analysis for brominated flame retardants for samples ABS 001, ABS 002 and HIPS 001	61
Table 6-3:	Transportation costs for export of flakes to Europe	76



**Acknowledgments:**

The activities described in this report were part of the MESTI-GIZ E-Waste Programme implemented in Ghana between August 2016 and January 2023. The exercise would not have been possible without the strong support and backing from MESTI and EPA.

Furthermore, the GIZ E-Waste team and the author of the study would like to emphasise in particular the close coordination with the EPA regarding the elaboration of the study. We would like to express our gratitude to Larry Kotoe for the close technical exchange and coordination of the specific issues addressed in this study. This ensured that the approaches regarding recycling of WEEE-thermoplastics proposed in the study are in line with the objectives of integrated e-waste management of Ghana.

We thank Latifatu Mohammed of CSIR, Accra Ghana for her support. We thank Dr. Stefan Reinemann from TITK - Thüringisches Institut für Textil- und Kunststoff-Forschung e.V., Rudolstadt, Germany for performing test on the material properties of recyclates. We thank Chris Slijkhuis from MGG Polymers for the testing of material samples and for his continuous and ongoing support.

Bernd Bungert acknowledges the support by the Berlin University of Applied Sciences and Technology (Berliner Hochschule für Technik, BHT) for granting him a research semester.

## **1. Introduction, goal of this study**

### **1.1. Targets of the KfW, GIZ e-waste programme**

Germany has started a bilateral cooperation with Ghana in 2016 to improve the conditions towards a sustainable e-waste management. The effort involves a technical cooperation project (the GIZ project related to this proposal) and a financial cooperation project (implemented by MESTI and KfW).

Since 2017 the GIZ E-Waste Program has been conducting assessments of the processes on the Old Fadama Scrap Yard (Agbogbloshie). Input- and output streams have been estimated, processes have been mapped and their relevance concerning environmental pollution and health hazards have been assessed. For selected processes like oil collection, dismantling of compressors, laptops, PCs, printers, microwaves detailed assessments have been conducted.

In 2019 the technical training center (TTC) at the scrap yard has been inaugurated, where the GIZ E-Waste Program provides training courses on environmental sound dismantling and recycling to scrap workers, workshop owners and other target groups.

Through the cooperation between the TC- and FC-component of the e-waste program on the implementation of an incentive system on the scrap yard the collection of critical fractions like cables, thermoplastics, batteries and CRTs from the informal sector to destine them to state-of-the-art formal further recycling has started. This incentive system creates the basis for the formal recycling sector in investing in further recycling technologies in the country. Several formal recycling companies have founded the e-waste recyclers' association EWROTA, some of them are in the process of preparing proposals to invest in further recycling under the call "The Investment Facility under the Special Initiative on Training and Job Creation" launched by KfW and GIZ on behalf of BMZ.

With the clearing of the Agbogbloshie scrap yard the E-Waste recycling sector in Ghana will be completely changed. The major part of the recycling business is dominated by the informal sector. However, formal recycling companies contribute a major share in the -Waste business. In order to develop the formal recycling sector, three major tasks have to be considered:

- 1) Investment into technical recycling solutions
- 2) Training and Capacity building on company level
- 3) Redirection of material flow from informal to formal sector to prevent the history of Agbogbloshie to occur again and to establish a sustainable E-Waste management system in Ghana

## **1.2. Aim of this compendium**

The aim of this compendium is:

- 1) To provide guidelines for collectors, aggregators, recyclers and plastic processors for the practical implementation of WEEE plastics recycling,
- 2) To evaluate business cases for WEEE plastic recycling
- 3) To evaluate material flows and to evaluate the social, environmental and economical impact of WEEE recycling.

## 2. Stakeholder analysis plastics sector and legal framework

The chapter on stakeholder analysis and legal framework is based on Mohamed (2022).

### 2.1. Practical actors

#### 2.1.1. Formal recycling companies

Table 2-1 gives an overview of the existing formal recyclers according to the EPA audits performed in 2020.

**Table 2-1: Formal recycling companies according to the EPA audits from 2020**

No.	Name of Entity	E-Waste value chain activity							
		Collection	E-Waste Dismantling	Repair/ Refurbishment	Transportation	Cable Recycling	ULABs Management	Fridge Degassing	Others
1	Blancomet Recycling Ltd	efg	fg		x	e	f		
2	J. Stanley Owusu								d
3	City Waste Recycling	beg	bg			e		g	
4	Green Advocacy Ghana	e							
5	Presank Enterprises Ltfd	g	g			e			
6	Recyclers Ghana Ltd	f	fg			e			
7	Caritas Ghana	abc							
8	Resell Ghana Ltd	ab	ab	a					
9	Integrated Recycling and Compost								d
10	Atlantic Recycling International Systems		ab	ab					
11	Succes Africa Ghana		f						
12	Sentuo Resources Ltd		agh			e			
13	Non ferrous Metals Ltd					e	f		
14	Eco-Star Environmental Ltd								d
15	Electro Recycling Ghana		b	b					
	a mobile phones								
	b computers and television								
	c mobile phones and computers								
	d Others (non-hazardous waste, oily waste, helathcare waste, etc.)								
	e cables								
	f lead-acid batteries								
	g fridges, air conditioners								
	h IT & telecommunication equipment								

Source: EPA

### 2.1.2. Plastics processors

The following list gives an overview of plastics manufacturers in Ghana. Most of these companies use recycled plastics as a source to replace virgin material. In part, they operate plastic recycling processes themselves.

#### **Bragha company Ltd.**

No. 10 Dadeban Rd, Accra

PET Water rolls, carrier bags, trash, bags, zip lock bags

<https://bragha.com/>

#### **Decorplast Limited**

29 Dadeban Road North Industrial Area, Accra

HDPE, LDPE, Furniture, Kitchen ware, basket, bathroom ware, Dustbin,

<https://decorplastgh.com>

#### **Everpack**

Ring road W. S. Industrial Area

HDPE, HDPE, Plastic microwave containers, Plastic disposable products

<https://www.everpack.net/products/>

#### **Ghana Rubber Products Ltd.**

Adjuma Cres, Accra

PET, HDPE, LDPE, Food bowls, food containers, garbage bag, Plastic cups

<https://ghanarubber.com>

#### **Interplast Limited**

109, Spintex Road, Accra

Unplasticized polyvinyl chloride polymer (uPVC), HDPE, uPVC pipes, Borehole pipes, cable duct, HDPE pipes, gas pipes, incurpipes, PPR pipes, warning mesh, irrigation systems, fence system, T &G, windows and doors

<https://interplast.com/>

#### **Kane-em Industries Ltd**

B625/8 Otublohum Road, North IND. Area

HDPE, LDPE Plastic containers for Food and Beverages, Pharmaceuticals, Industrial Containers, K-Caps, Cosmetics and household Products, Toys

<https://www.kaneem.com/>

#### **Miniplast Ltd**

80. Spintex Road, Accra

Industrial buckets, jerry cans, multipurpose containers, tabletcontainers, tables, chairs

<https://miniplast.com>

#### **New Star Poly Products Ltd –POLYSTAR**

Tema, 024 435 9043

PVC, HDPE, LDPE, PET, PVC pipes, chairs, storage tanks, flower pots

<https://polystargh.com>

**Poly Products Gh. Ltd**

Accra

LDPE/HDPE, Polypropylene film and shopping bags, as well as flexible packaging

**Poly Tank(s) Ghana Limited**

Motorway Industrial Estate

PP, PET, HDPE, Storage tanks, waste bins, fish ponds, fishing boats, poykiosk, industrialtrolley, mobile toilets, plastic palettes, biodigesters, septic tanks, PET bottles, laminates, sacks

<https://www.polytankgh.com/>

**Polytex Industries Limited**

9 Dadeban Road North Industrial Area, Accra

PET, HDPE, Polytex, Polyprint, Polypet

<https://polytexgh.com/>

**Qualiplast Ltd Abotia Street**

North Industrial Area

PET, HDPE PET bottles, containers, basins, baskets, beach buckets, tables, chairs, coolers, dustpans, crates, mugs, jerry cans, plates, spoons etc.

[www.Qualiplast.com](http://www.Qualiplast.com)

**Sintex Container Ghana Ltd**

80. Spintex Road, Accra

PP, PET, HDPE, PET preforms, storage tanks, bottles, refuse bins, caps and closures, polybags, packaging materials

<http://www.sintexghana.com>

## **2.2. Summary of relevant laws and regulations**

This chapter gives a brief overview on the most important national and international laws related to WEEE plastics recycling.

### **2.2.1. International**

#### **Basel Convention on the Control of Trans-boundary Movements of Hazardous Wastes and Their Disposal (United Nations treaty, 1992)**

Designed to limit the generation and movements of waste between nations, and explicitly to prevent the transferal of hazardous waste from developed to developing countries. The ammendment on plastic waste B3011 gives further details. Only if waste has been preprocessed and has a purity of more than 98% it will be considered as „green listed waste“. Otherwise a rather complicated notification process needs tob e done.

According the our analysis the materials clearly meet the requirements of the therefore recommend to declare the process operated by ERG as compliant to produce „green listed waste“. I also recommend to declare the recyclates obtained by that process as

**Waste Shipment Regulation 2006 (Regulation (EC) No 1013/2006 of the European Parliament and of the Council of 14 June 2006 on shipments of waste)**

The Regulation implements the Basel Convention, which bans exports of hazardous waste from OECD countries to non-OECD countries. According to the Regulation, all hazardous waste, as well as some problematic waste streams and other wastes defined therein, must be notified to the authorities before the shipment across borders is allowed. The terms 'export' and 'import' are used for transboundary waste shipments, both for shipments within the EU and for shipments to third countries.

**Stockholm Convention on Persistent Organic Pollutants (United Nations treaty, 2004)**

Formulated to eliminate or reduce the releases of persistent organic pollutants into the environment. Key elements are the requirement that developed countries provide new and additional financial resources and measures to eliminate production and use of intentionally produced POPs and manage and dispose of POPs wastes in an environmentally sound manner.

**POP Regulation (EU) 2019/1021 on persistent organic pollutants**

The POP regulation gives detailed rules on production and use of persistent organic pollutants in the EU. It implements the Stockholm convention.

**WEEE Directive–2004 (European Community Directive 2012/19/EU)**

The WEEE Directive sets collection, recycling and recovery targets. The WEEE directive sets a total of 6 categories of WEEE for reporting purposes. There are six categories of discarded electronic waste:

- 1) Large household appliances (“white goods”), e.g. washing machines, refrigerators, freezers;
- 2) Small household appliances (also “white goods”): e.g. toasters, coffee makers, microwaves;
- 3) Information and communication technology devices such as computers, monitors, printers, mobile phones, telephones;
- 4) Consumer electronics devices (“brown goods”) such as television sets, video recorders, digital cameras;
- 5) lamps (such as gas discharge lamps, LEDs);
- 6) PV modules.

**RoHS, Restriction of Hazardous Substances Directive 2002/95/EC (RoHS 1), short for Directive on the restriction of the use of certain hazardous substances in electrical and electronic equipment**

The initiative was to prevent an overabundance of chemicals in electronics. This directive restricts (with exceptions) the use of ten hazardous materials in the manufacture of various types of electronic and electrical



equipment. It is closely linked with the Waste Electrical and Electronic Equipment Directive. It restricts the use of the following ten substances to a maximum permitted concentration of 0.1% (0.01% for Cadmium).

1. Lead (Pb)
2. Mercury (Hg)
3. Cadmium (Cd)
4. Hexavalent chromium (Cr<sup>6+</sup>)
5. Polybrominated biphenyls (PBB)
6. Polybrominated diphenyl ether (PBDE)
7. Bis(2-ethylhexyl) phthalate (DEHP)
8. Butyl benzyl phthalate (BBP)
9. Dibutyl phthalate (DBP)
10. Diisobutyl phthalate (DIBP)

### **2.2.2. National**

The most relevant national laws and regulations are:

#### **Environmental Protection Agency Act, 1994 (Act 490)**

To ensure compliance with standards regarding all kinds of pollutants and waste that have adverse effects on the environment and to regulate the import, export, manufacture, distribution, sale and use of pesticides and others.

#### **Merchant Shipping (Dangerous Goods) Rules, 1974 (LI 971)**

To facilitate the proper handling and segregation of dangerous substances (flammable gases, vapours, explosives, oxidizing, poisonous, infectious, radioactive and corrosives) from human contact or foodstuffs

#### **Export and Import Act, 1995 (Act 503)**

Sets rules for export and import of goods.

#### **Hazardous and Electronic Waste Control and Management Act 2016 (Act 917)**

The Hazardous and Electronic Waste Control and Management Act provides for the control, management and disposal of hazardous waste, electrical and electronic waste and related products. It includes a schedule that designates the categories of waste to be controlled, as well as a list of wastes with specific elements such as arsenic, zinc, cadmium, etc. The Act prohibits the transportation, sale, purchase, as well as import and export, of hazardous wastes or other waste as classified in the schedule; it also provides definitions on what used equipment is.

The Act also specifies the establishment of an **Electrical and Electronic Waste Management Fund (EEWMF)** whose objective is to finance the management of EE waste and reduce the negative impact of EE waste on human health and environment.

### **The Legislative Instrument on Hazardous and Electronic Waste Control and Management Regulations 2016 (LI 2250)**

The Act is complemented by the Legislative Instrument on Hazardous and Electronic Waste Control and Management Regulations which set multiple objectives, among which are the regulation of the classification, control and management of waste or the requirements for the disposal of waste. The regulation also provides a comprehensive list of electric and electronic items which will attract a levy, and their prescribed levy. It also spells out the appropriate and relevant regulations guiding the classification and implementation of the Act.

### **2.3. Pilot incentive system implemented by MESTI-PIU in cooperation with KfW**

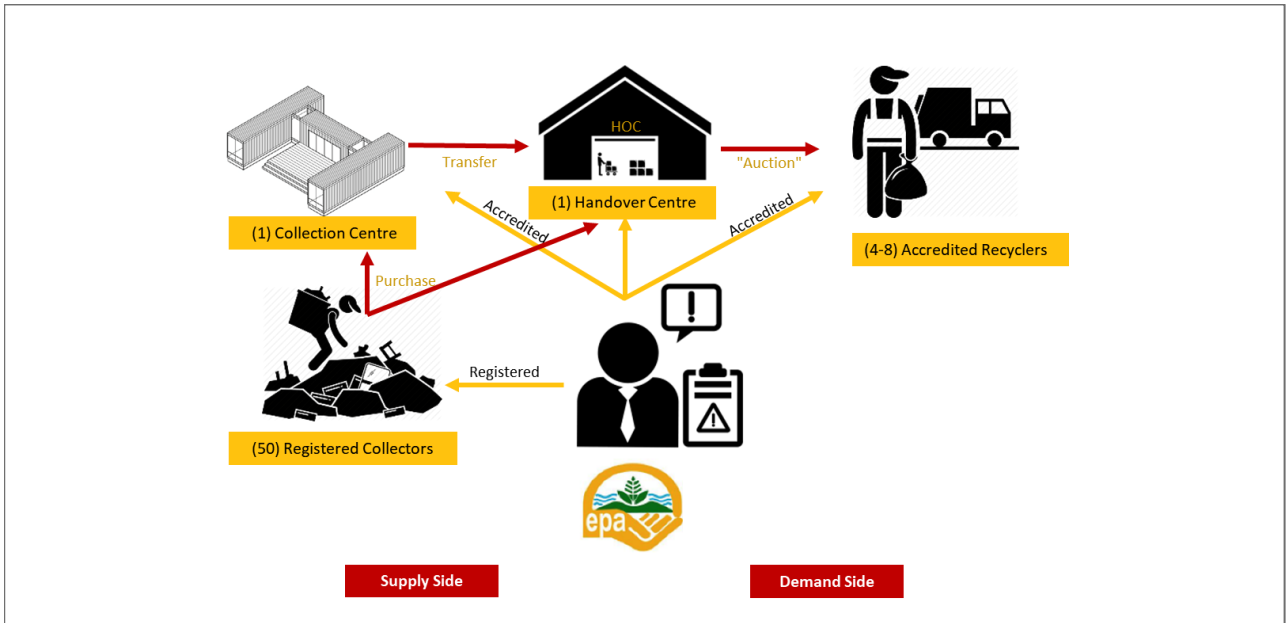
The Ministry of Environment, Science, Technology and Innovation (MESTI) together the Environmental Protection Agency (EPA) as well as Kreditanstalt für Wiederaufbau (KfW) work on piloting of a WEEE collection system in Ghana.

The aim of that system is fivefold:

1. Minimize negative environmental and human health impacts from improper management of electronic wastes;
2. Transition the most polluting e-waste recovery activities from the informal sector to the formal sector;
3. Enable sustainable growth and open-market enterprise within the private-sector led recycling industry;
4. Test a financial/pricing mechanism for sound recycling;
5. Support the National System with lessons learned.

The core idea is that informal recyclers and collectors bring waste to the collection and handover centre and receive a price that is sufficiently motivating for them. The waste is then sold to formal recyclers. These are subject to environmentally sound methods. Thus supply side and demand side shall be brought together. The programme is ongoing.

Figure 2-1: EPA WEEE collection system



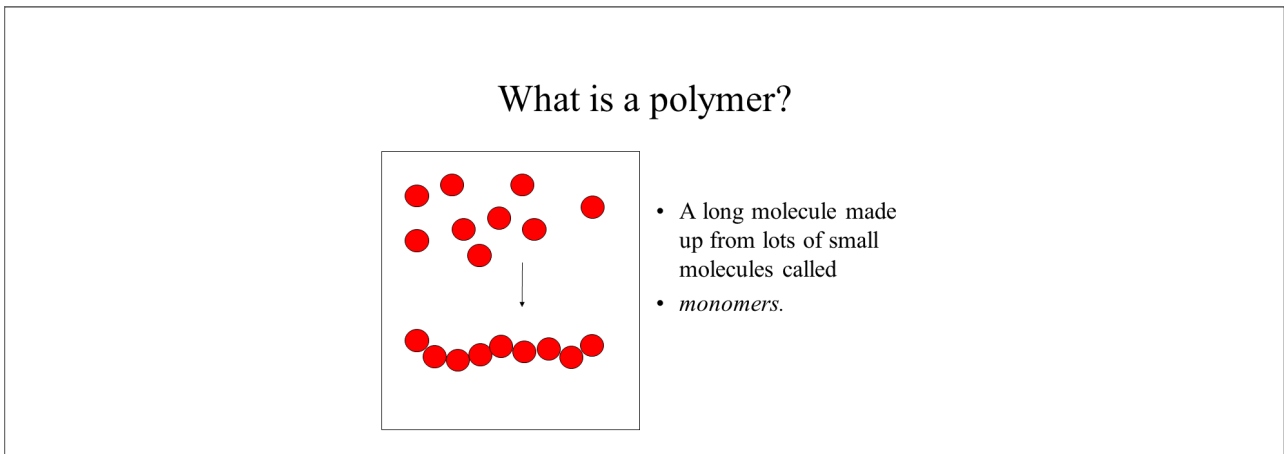
Source: EPA, MESTI, GIZ, KfW

### 3. Basics of plastics: types, properties, processing

#### 3.1. Plastics and polymer basics








Plastics consist mainly of polymers which are macromolecules composed of repeating units, the monomers. Typically, the number of repeating units lies in the order of 1000 – 10,000 or more.

Figure 3-1: What is a polymer?



Source: Wikipedia

The most common polymers are six major types. They are labelled according to their resin identification code (RIC). They comprise almost 70% of the worldwide annual production:

	Polyethylene terephthalate	(PET)
	High-density polyethylene	(HDPE)
	Polyvinylchloride	(PVC)
	Low-density polyethylene	(LDPE)
	Polypropylene	(PP)
	Polystyrene	(PS)
	All other polymers have the RIC "other"	

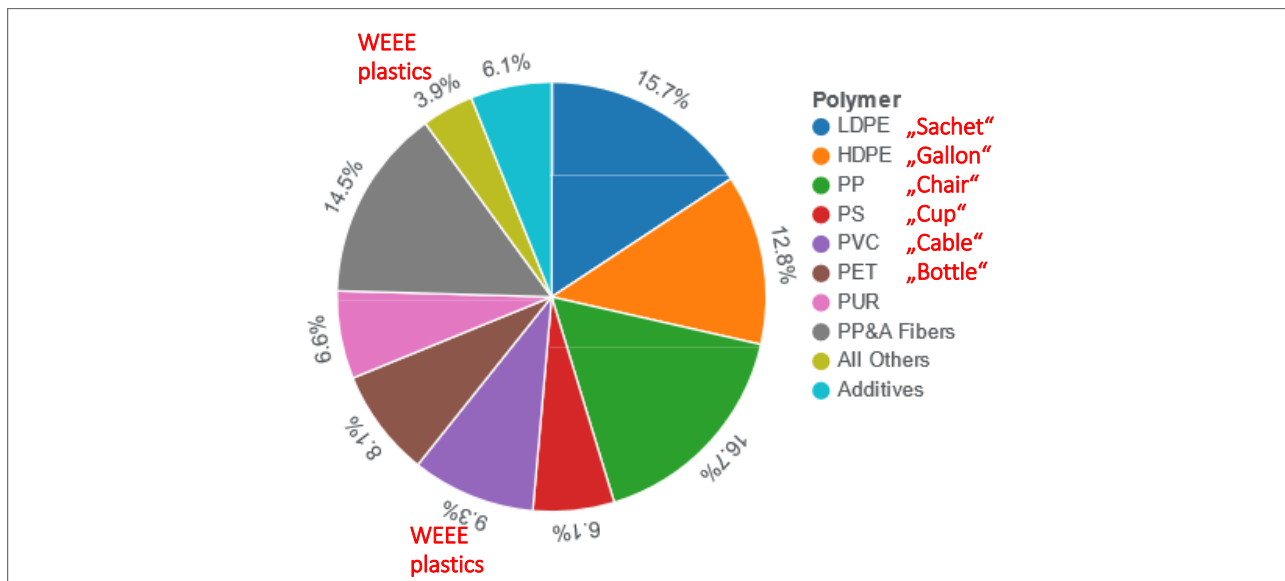
The following table and figures list the most common polymers, their annual production as well as their use.

**Table 3-1: Most commonly used polymers by production**

Global plastic production by polymer type (2015)[22]				
Polymer	Production (Mt)	Percentage of all plastics	Polymer type	Thermal character
Low-density polyethylene (LDPE)	64	15.7%	Polyolefin	Thermoplastic
High-density polyethylene (HDPE)	52	12.8%	Polyolefin	Thermoplastic
polypropylene (PP)	68	16.7%	Polyolefin	Thermoplastic
Polystyrene (PS)	25	6.1%	Unsaturated polyolefin	Thermoplastic
Polyvinyl chloride (PVC)	38	9.3%	Halogenated	Thermoplastic
Polyethylene terephthalate (PET)	33	8.1%	Condensation	Thermoplastic
Polyurethane (PUR)	27	6.6%	Condensation	Thermoset <sup>[26]</sup>
PP&A Fibers <sup>[25]</sup>	59	14.5%	Condensation	Thermoplastic
All Others	16	3.9%	Various	Varies
Additives	25	6.1%	-	-
<b>Total</b>	<b>407</b>	<b>100%</b>	-	-

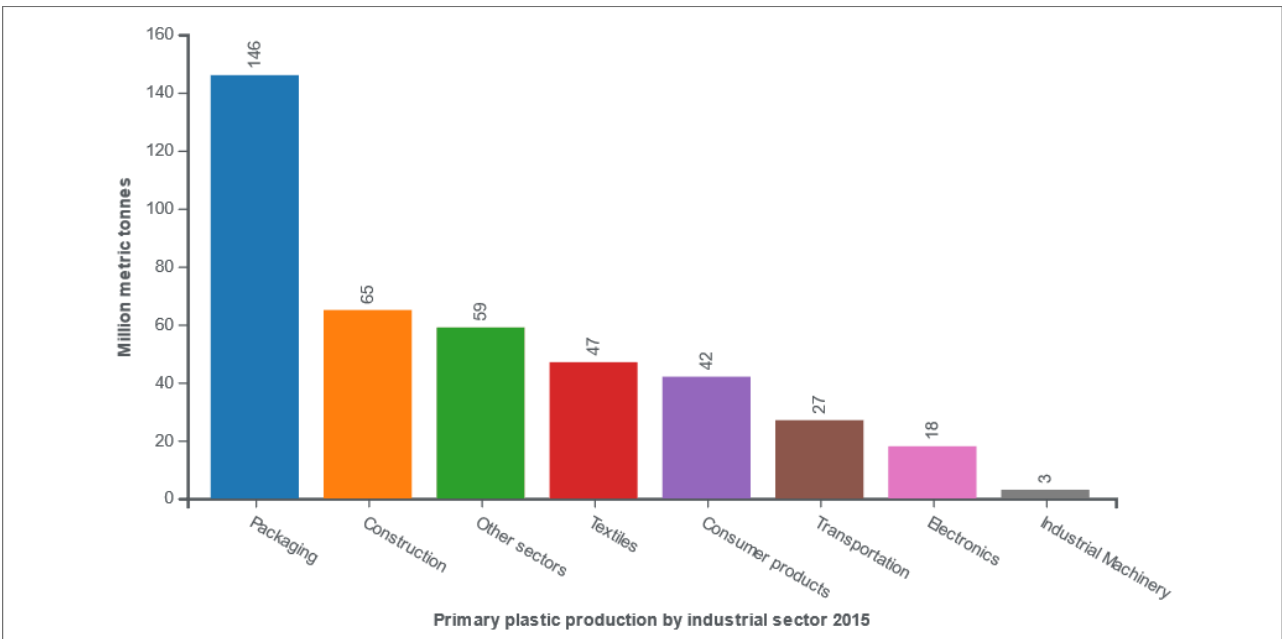
Source: Wikipedia

**Figure 3-2: Most commonly used polymers by production, their common name in Ghana and polymers used in WEEE plastics**



Source: Wikipedia, adopted

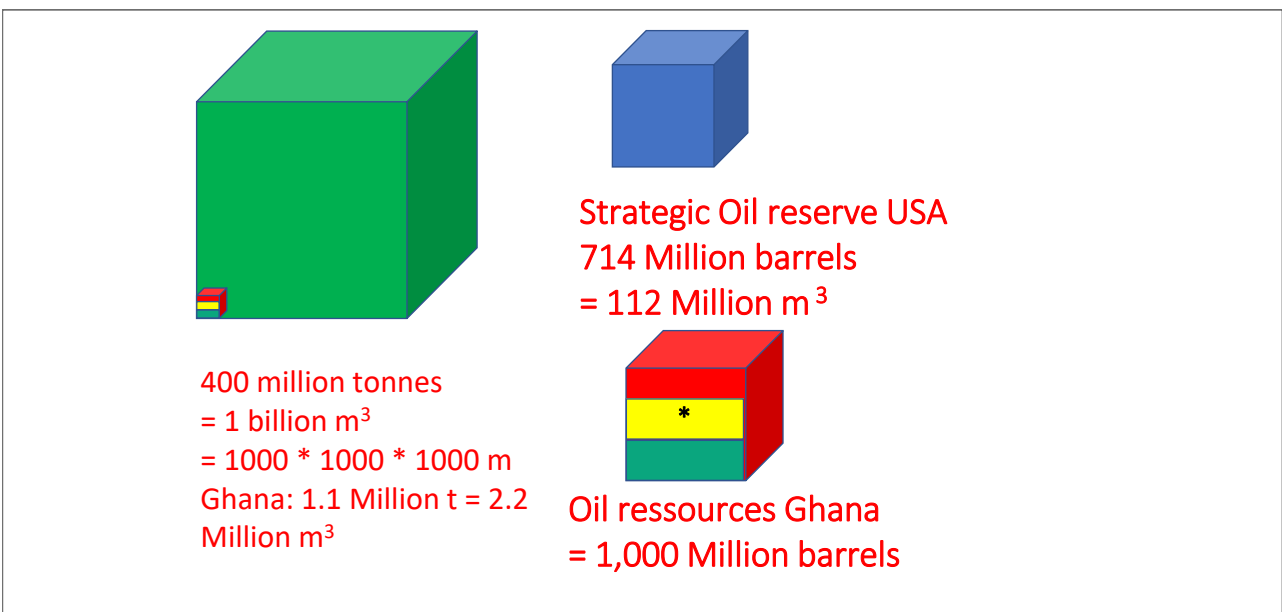
**Figure 3-3: Most common plastics by use**



Source: Wikipedia

As a reference, Figure 3-4 shows the volumes of the plastics produced worldwide, the amount of plastics being consumed in Ghana assuming a bulk density of about 500 kg/m<sup>3</sup> as well as the volume of the strategic oil reserves of the USA and the oil reserves of Ghana.

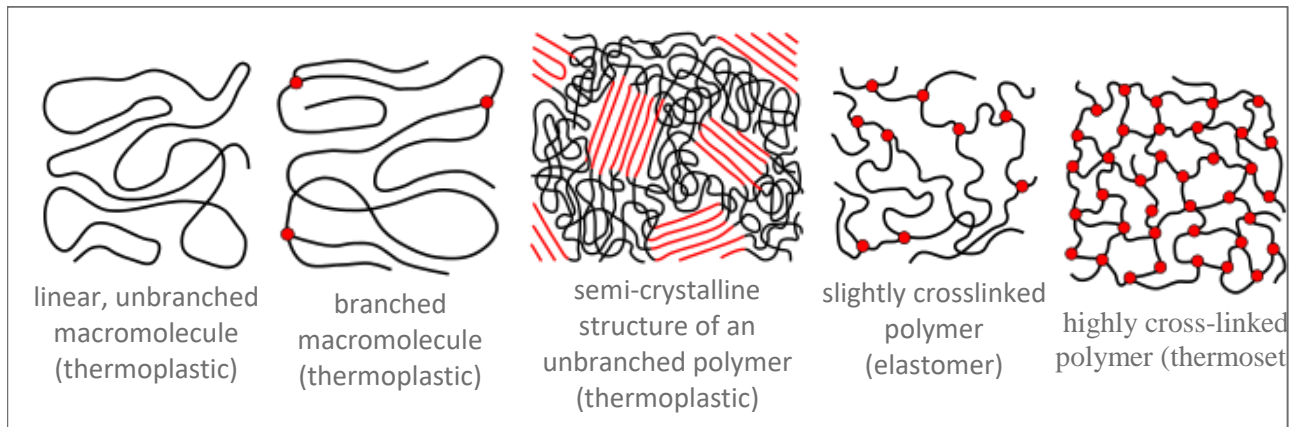
**Figure 3-4: Worldwide plastics production of 400 million tonnes = 1 billion m<sup>3</sup>: order of magnitude**



Source: this work

Polymers can have different microstructure depending on the type as well as on the reaction conditions during production. Below there are some basic examples.

**Figure 3-5: Microstructure of polymers**



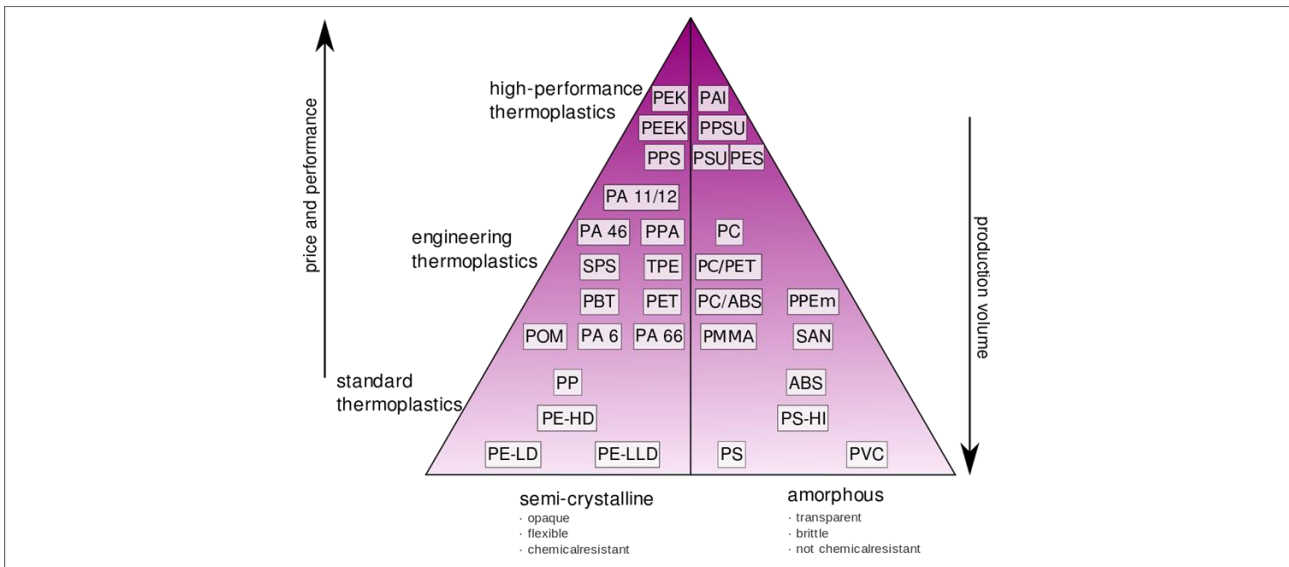
Source: Wikipedia

Depending on the amount of branching in the molecules they exhibit different degrees of crystallinity. Some polymers are amorphous (i.e. glass like) like polystyrene. They are typically transparent. Others consists of areas, where the molecules are arranged in parallel. These polymers can be opaque. When the polymers are only partly crystalline, they are called semi-crystalline. PE, LDPE, HDPE, PVC and Nylon belong to this class. Crystallinity also affects the mechanical properties. LDPE has strongly branched molecules that can hardly align in parallel while HDPE consists of more linear molecules and is therefore more crystalline. As a result, LDPE is less rigid and is thus used for making films and plastic bags.

Figure 3-6 shows the most common polymers, their crystallinity, price, performance and production volumes in a qualitative manner.



**Figure 3-6: Price, performance and production volumes of various polymers**



Source: Minihaa, Wikipedia

According to their microstructure polymers can also be classified into

- **Thermoplastics** are moldable at elevated temperatures and solidify upon cooling. They can easily be recycled.
- **Thermosets** are made by irreversible hardening or crosslinking of polymer chains. Therefore, they cannot be recycled.
- **Elastomers** are not hard but rather elastic due to the decreased amount of crosslinks compared to thermosets. They are commonly referred to as rubber. They cannot be recycled.

For practical application the properties of polymers are being changed or adopted to their use. That comprises e.g. resistance, softness, color. This change can be achieved by the use of **additives**. These can be plasticizers, fillers, pigments, stabilizers, flame retardants and others.

Generally spoken one can say: plastic = polymer + additive.

**Figure 3-7:           What is a plastic?**

**Polymer + additive = plastic**

---

### 3.2. Plastics processing

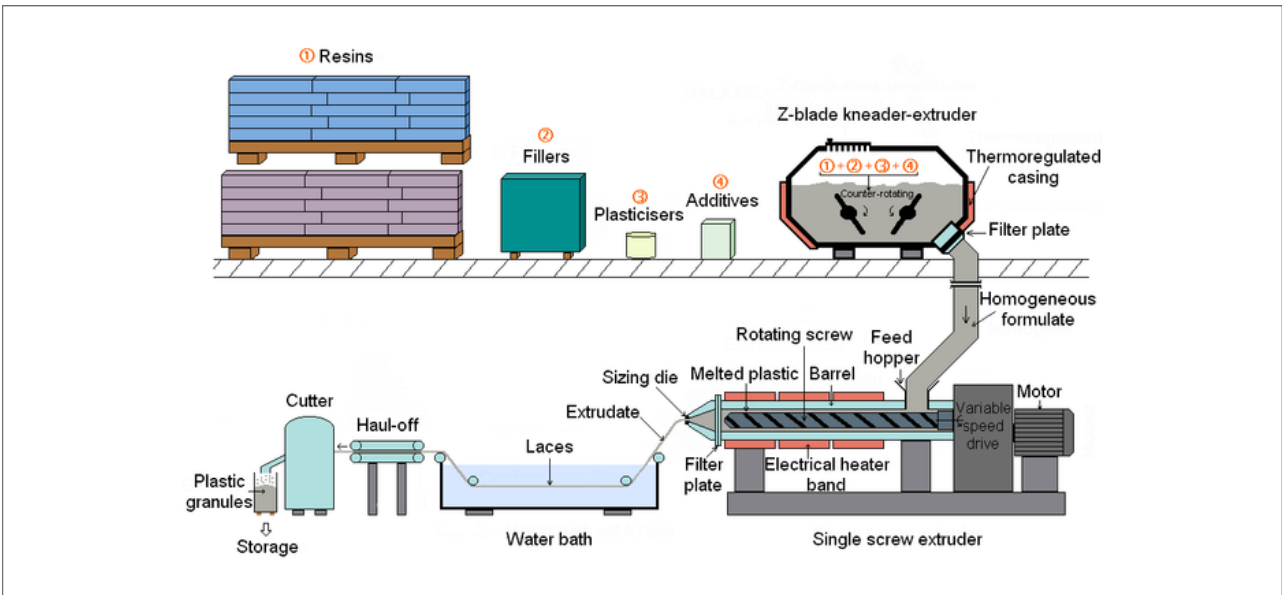
After production by reaction, processing can be done by a number of methods. These are listed below.

**Table 3-2: Plastics-processing methods**

Nr.	Processing method	Technology	Technology level	Application
1	Extrusion, compounding, pelletization	Melting of plastics in an extruder with subsequent pelletization or granulation through underwater pelletizing or strand pelletization	medium	Production of pellets for further processing, compounding, i.e. mixing of polymers (plastics) with additives
2	Injection moulding	Injection of a molten plastic into a cavity or mould under high pressure and temperature.	high	Solid objects (TV casings, phones)
3	Film blowing	Feeding polymer melt through a die to shape a tube-like strand that is subsequently inflated.	high	Plastic bags, sheeting
4	Blow moulding	Injection of a polymer melt into a preform that is inflated and cooled.	high	Bottles, toys
5	Extrusion	Extrusion of polymer melt through a die to form pipes or profiles.	medium	Pipes, profiles of different shapes
6	Thermoforming	Melting a polymer sheet and pressing it into a mould	low	Cheap method for prototypes, car panels, food packaging etc.
7	Vacuum forming	Melting a polymer sheet and pressing it into a mould with vacuum	low	Cheap method for prototypes, car panels, food packaging etc.
8	Foam moulding	(Injection) moulding with pellets that contain gas. Upon melting the gas expands, forms a foam and solidifies.	high	Insulation material, all kinds of foamed products
9	Rotational moulding	Charging a heated mold with plastic. It is then slowly rotated (usually around two perpendicular axes), causing the softened material to disperse and stick to the walls of the mold forming a hollow part.	high	IBC tanks, „polytanks“
10	Spinning			Fibre production (Nylon, Polyester (PET))

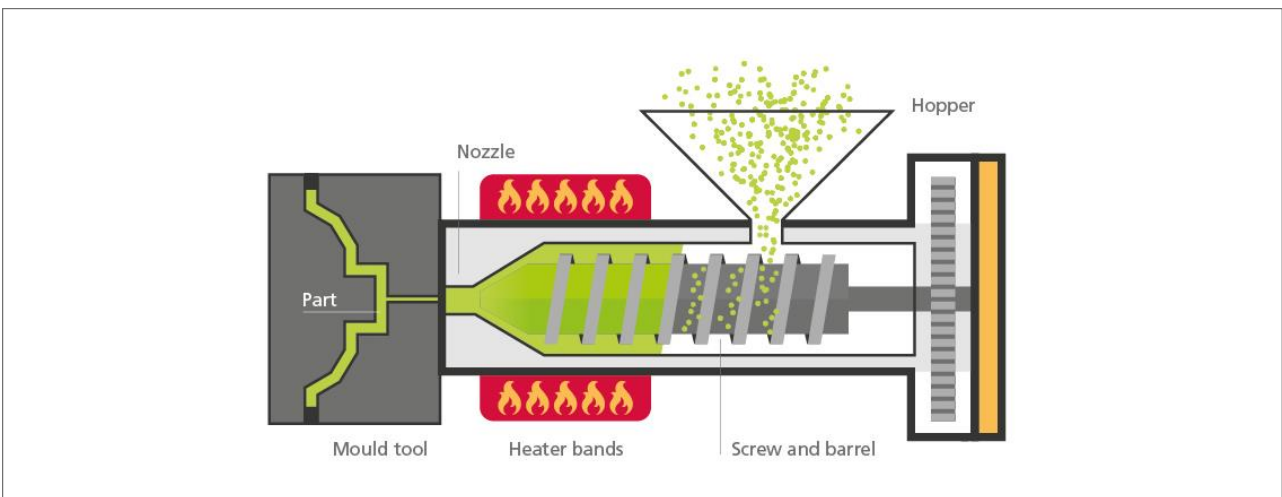
The following figures visualize the most important methods of plastics:

**Figure 3-8: Processing method 1: extrusion, compounding, pelletization**



For the use of plastics in further processing in almost all the cases it is necessary to process them into pellets and to use additives for stabilization, colouring etc. This is typically done in a mixer and extruder setup with subsequent granulation or pelletization.

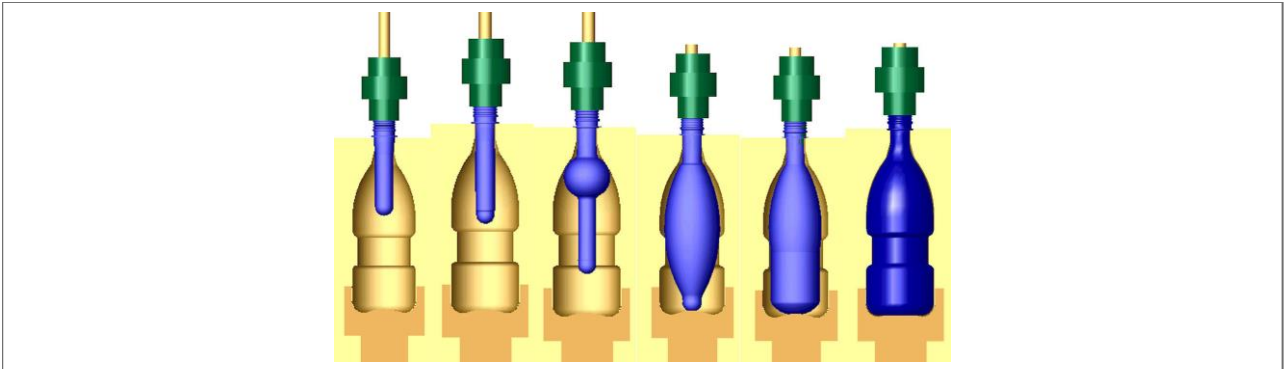
**Figure 3-9: Processing method 2: injection moulding**



Pellets can be fed into another extruder and then be injected into a mould as one processing method. Injection moulding requires the use of very neatly machined moulding tools. These can be bought and are rather price intensive. Alternatively, they can be machined by CNC lathes and CNC milling machines. This can be considered as a high technology level and requires very well-trained personnel.

---

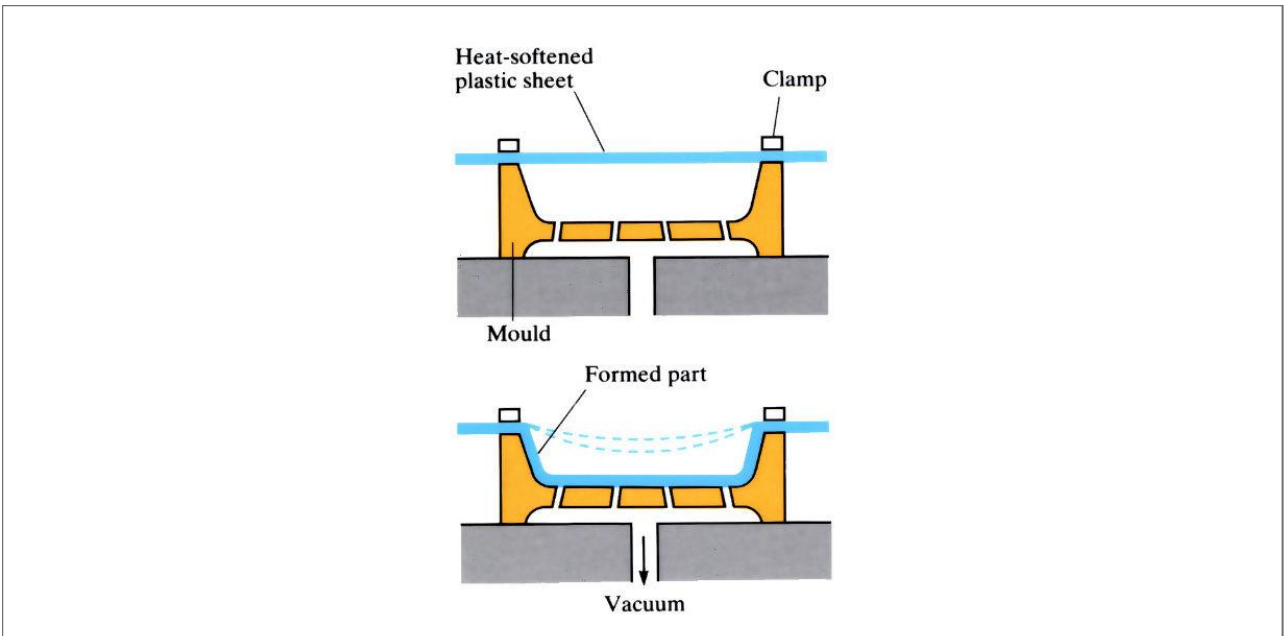
**Figure 3-10: Processing method 4: blow moulding**



Blow moulding is the standard method for the production of bottles. First, preforms are produced by injection moulding. These are then further processed in the blow moulding step.

---

**Figure 3-11: Processing method 7: vacuum forming based on sheets**



Vacuum forming uses plastic sheets that can be rather easily produced. With the help of vacuum the heated and thus softened sheets are drawn onto a mould with the help of vacuum. Moulds can easily be hand made

with any tool. Due to the simplicity this method can be applied by small workshop and therefore seems suitable for small-scale production of parts from recycled plastics.

---

**Figure 3-12: Processing method 8: rotational moulding**



---

Rotational moulding is the standard method for the production of large plastic tanks like “polytanks” or “Sintex tanks”.

### **3.3. Plastics additivation**

To adapt the properties of polymers to the final need, additives are used. Also in plastics recycling additives are being used, especially to stabilize the product (antioxidants) or to compatibilize, i.e. help to dissolve impurities from other polymers in the matrix of the main polymer which is crucial in plastics recycling. Incompatibility is one of the major obstacles in plastics recycling and is described in detail in chapter 4.

Additives can leach out of the plastics during use or in landfills. Typical examples for dangerous substances are brominated flame retardants from ABS or HIPS, bisphenole-A from polycarbonate bottles and plasticizers like phthalates from PVC. Chapter 5 deals with that issue.

Waste plastic, even if it is all of the same polymer type, will contain varying types and amounts of additives as well as colours. This will affect the properties of the recyclate. The colour of mixed recycled plastics if not sorted by colour will typically appear grey to black as a result of mixing soluble colours as well as pigments or different types.

Table 3-3: Plastic additives, their use and global production share Table 3-3 gives an overview of the most common additives, examples and their share in global production. Very detailed information on plastic additives can be found in (Zweifel *et al.* 2009).

**Table 3-3: Plastic additives, their use and global production share**

Additive type	Typical concentration when present (%)	Description	Example compounds	Comment	Share of global additive production
Plasticizers	10–70	Plastics can be brittle, adding some plasticizer makes them more durable, adding lots makes them flexible	Phthalates are the dominant class, safer alternatives include adipate esters (DEHA, DOA) and citrate esters (ATBC and TEC)	80–90% of world production is used in PVC. For most products loadings are between 10 and 35%	34%
Flame retardants	1-30	Being petrochemicals, most plastics burn readily, flame retardants can prevent that	Brominated flame retardants, chlorinated paraffins		13%
Heat stabilizers	0.3-5	Prevents heat related degradation		Almost exclusively used in PVC.	5%
Fillers	0-50	Changes appearance and mechanical properties, can reduce price	Calcium carbonate "chalk", talc, glass beads, carbon black. Also reinforcing fillers like carbon-fiber	Most opaque plastics contain fillers. High levels can protect against UV rays.	28%
Impact modifiers	10-40	Improved toughness and resistance to damage.			5%
Antioxidants	0.05–3	Protects against degradation during processing	Phenols, phosphite esters, certain thioethers	The most widely used type of additive. All plastics contain stabilizers of some sort.	6%
Colorants	0.001-10	Imparts colour	Numerous dyes or pigments		2%
Lubricants	0.1-3	Assists in molding the plastic, includes processing aids (or flow aids), release agents, slip additives	Paraffin wax, wax esters, metal stearates (i.e. zinc stearate), long-chain fatty acid amides (oleamide, erucamide)		2%
Light stabilizers	0.05–3	Protects against UV damage	HALS, UV blockers and quenchers	Normally only used for items intended for outdoor use	1%
Other		Various	Antimicrobials, antistatics, blowing agents, nucleating agents, compatibilizers		4%

### 3.4. Material properties and material testing

The relevant material properties comprise those for handling, processing and the end use of the product.

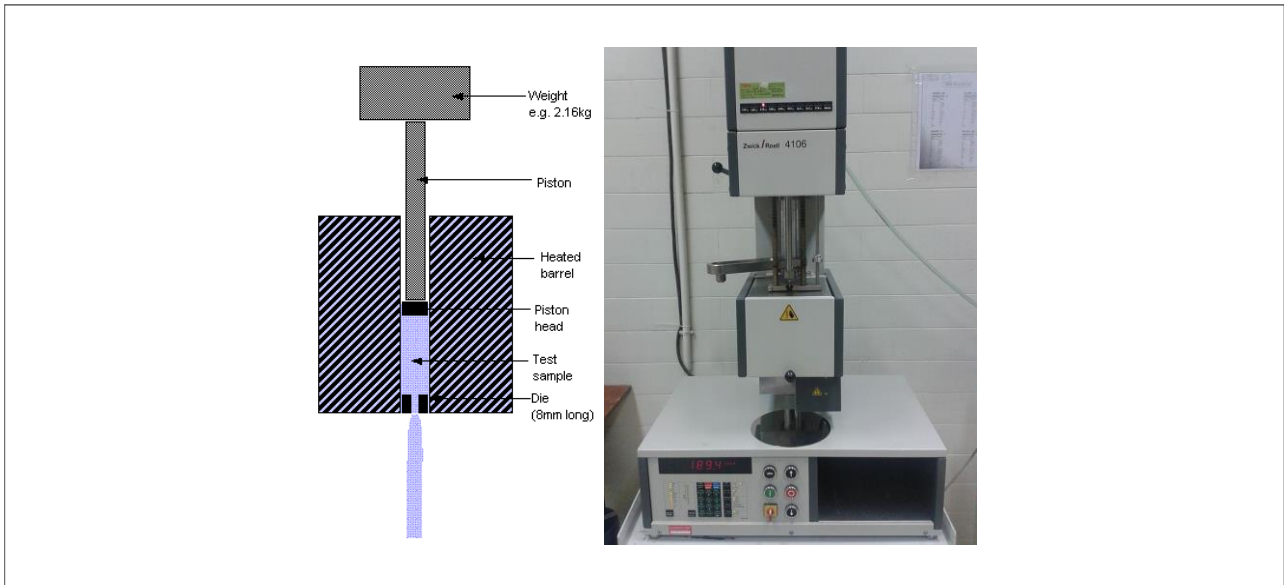
The most important properties are:

**Melt flow index (MFI)**, also called melt-flow rate (**MFR**) or melt volume rate, (**MVR**) is a measure of the viscosity of a polymer. It is the mass or volume flowing through a specified capillary when a weight is applied



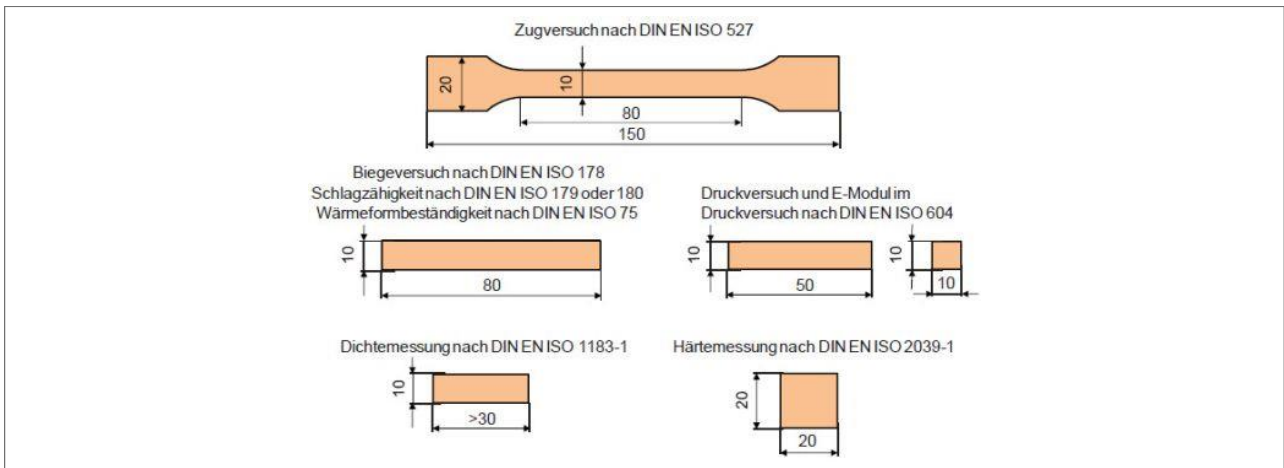
through a piston and the temperature is adjusted to a specified value (Figure 3-13). The MFI correlates with the grade of a polymer, i.e. its molecular weight (distribution) that is relevant for processing as well as product type, e.g. injection moulding or extrusion. In injection moulding of hollow parts thin walled bottles of HDPE (“pesticide bottle”) and thick walled containers (“jerrycan”, “gallon”) that require different MFIs when being injection moulded.

**Figure 3-13: Experimental setup to determine MFI (MFR, MVR)**



**Tensile modulus** (Youngs modulus), **yield stress**, **stress at break**: These properties are all derived from the stress-strain curve obtained by a tensile test. First, test bars are produced by injection moulding. They are then used to perform a tensile test to obtain the stress-strain curve, see Figure 3-14, Figure 3-15, Figure 3-16.

**Figure 3-14: Test bars for tensile test to obtain stress-strain curve (measures in millimeters)**



**Figure 3-15: Equipment for tensile test to obtain stress-strain curve**

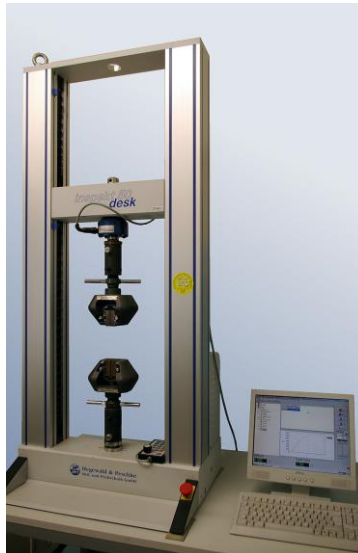
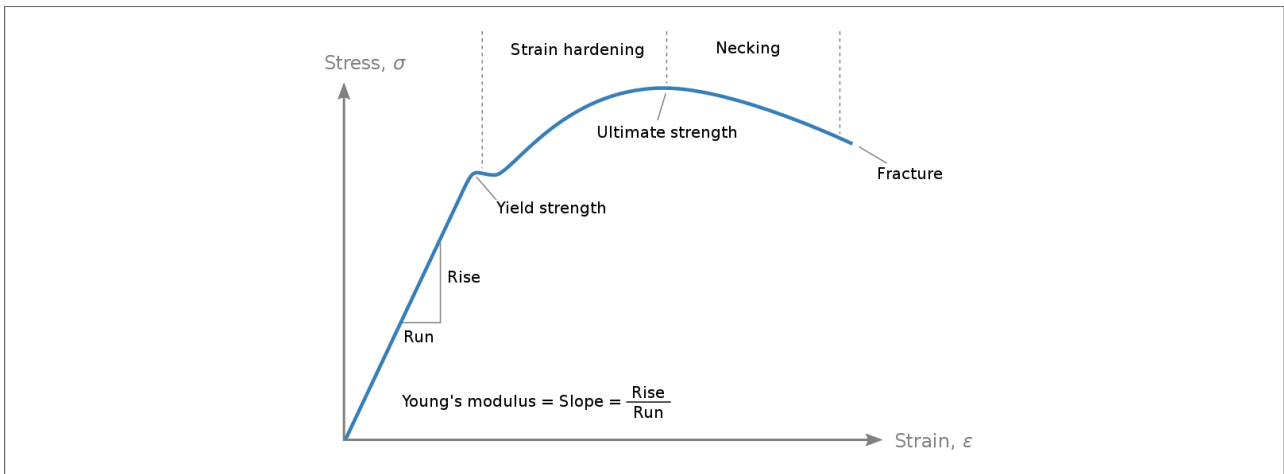


Photo: Rainer Knäpper, Free Art License (<http://artlibre.org/licence/lal/en/>), [https://commons.wikimedia.org/wiki/File:Inspekt\\_desk\\_50kN\\_IMG8563.jpg](https://commons.wikimedia.org/wiki/File:Inspekt_desk_50kN_IMG8563.jpg)

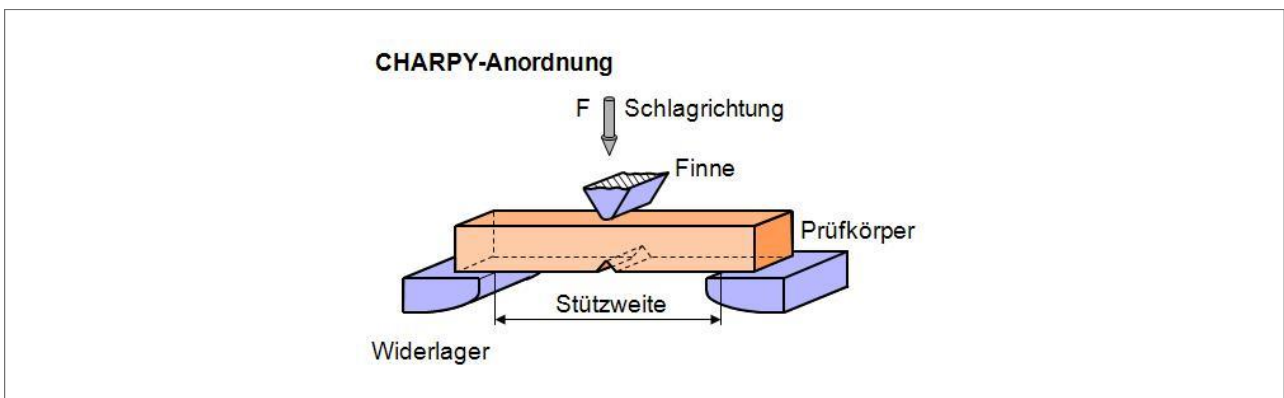
**Figure 3-16: Stress-strain curve obtained from tensile test**



The **tensile strength** of a material quantifies how much tensile stress the material will endure before break. The **Youngs modulus** quantifies the elasticity of a material. It is the ration of stress to strain and thus the slope of the curve. **Yield stress** gives the stress where permanent deformation of the material is reached while **stress at break** denominates the stress at final failure of the material.

**Impact strength** is measured according to the Izod method or the Charpy method. It shows how much impact a material can absorb before failure. This is an important value for materials of everyday use. Materials with high impact strength are ABS (acrylonitrile-butadiene-styrene copolymer) as well as high-impact polystyrene (HIPS). These are the two most important polymers in WEEE plastics recycling. See Figure 3-17

**Figure 3-17: Measuring principle for determination of impact strength**



The **Vicat softening temperature** or **Vicat hardness** is the softening point for materials that do not have a definite melting point. It is the temperature at which a sample is penetrated to a depth of 1 mm by a flat-ended needle.

The **density** of a polymer is crucial for engineering design. Furthermore, one can make use of the density in float-sink separation of plastics. However, it must be noted that additives like plasticizers and especially mineral fillers can change the density severely. This is especially true for cables made from PVC, PE, polyurethane and PP. Due to the large variety of these materials the density of these materials overlaps. Therefore, a density separation of plastics obtained from cables is definitely not possible.

**Bulk density** is the weight per volume of bulk commodities. It is an important value for the determination of transport costs. Plastic pellets from pelletization typically exhibit bulk densities that are about half the density of the plastic itself. It depends on the amount of voids (air) between the particles. For large plastic parts piled after collection in recycling it can be less than 10% of the density of the plastic itself. By crushing (shredding) it can be increased.

## 4. Technical principles of plastics recycling

This chapter gives an overview of methods and processes for plastics recycling especially suitable for application in Ghana. Reference is given to some methods and processes that are of high technology level or require high investments. Technical obstacles for plastics recycling are explained.

Nr.	Description	Tool/ Technology	Critical succes factor	PCP	EWP	Cables
1	Hand sort (identification by application (bottle, chair, ...))	Hand, knowledge	proper identification, mixed plastics have very bad quality	x	(x)	
2	Hand sort (identification by tests, e.g. solvent, scratch, bend, ...)	Hand, knowledge	proper identification, especially of (HIPS) - (ABS, ABS/PC) mixed plastics have very bad quality		(x)	
3	Hand sort (distinguish copper and aluminum)	Hand, knowledge	-			x
	Hand sort (distinguish cable plastics according to labels and colors)	Hand, knowledge	<i>no international standard, only theoretically applicable</i>			(x)
4	Delabeling	kitchen knife, hand	quality, productivity	x	(x)	
5	Cutting	cutlass, machete	personal safety	x	(x)	x
6	Shredding	shredder	throughput, wear of knives -> cost for spare parts	x	(x)	x
7	Washing	vessel, washing p., baking soda	proper mixing. Best done in concrete mixer	x	(x)	
8	Drying	open, on plastic sheets	No contamination with sand or dust		(x)	
9	Float-Sink separation with water	open vessel	-		(x)	
10	Float-Sink separation with salt solutions	open vessel	determination and adjustment of concentration	x	(x)	
11	Magnetic separation	machinery <i>not used in Ghana</i>	-		(x)	
12	Electrostatic separation	machinery, triboelectric charging, <i>not used in Ghana</i>	material must be dry and metal free		(x)	
13	Sifting	Separation in air stream	adjustment of throughput and flow			x
14	Sedimentation/ water washing table	Separation in water flow	adjustment of throughput and flow			x

### 4.1. Obstacles for high-value recycling

#### 4.1.1. Particles

Recycled plastics contain a variety of particles that can severely affect the quality of the final product. These can be e.g. dust, stones, wood, plastic foam. Special care has to be taken when plastics are dried and processed. Plastics processors commonly use melt filter after their extruders in order to retain particles.

#### 4.1.2. Colour

Once mixed it is hardly possible to change the colour of plastics. Mixed recycled plastics show a typical mixture of grey, black and brown. In Ghana a common practice is to sort plastics according to their type and colour.

#### **4.1.3. Odour**

Odour is a common problem in European recyclates. This originated from the fact that typically all plastics are collected together in different kinds of plastics collection system. Consumers are not obliged to clean the plastics they dispose of. Odour therefore is a common problem with PCR's like PS, PE, PP. PET as well as WEEE plastics are an exception of this point.

In Ghana, due to the different system, odour is not a major issue.

#### **4.1.4. Incompatibility**

Differences in polarity like between water and oil lead to the formation of two liquid phases ("layers"). Molecules and also monomers interact thermodynamically. The slightest difference between the molecules or monomers is amplified, because each polymer molecule consists of 1000 or more monomer units. A general rule is that polymers demix in the liquid state i.e. in the melt and form two liquid phases. Hence, the mechanical properties are very poor. To avoid that, sorting and separation need to reach purities of about 99% or even more. This point is absolutely crucial for successful recycling. In some cases compatibilizing agents can be used. Figure 4-1 gives an overview for the major plastic types. A rare exception from the rule are blends between polycarbonate and ABS, PC/ABS blends. They are indeed used commercially.

Figure 4-1: Incompatibility of different plastics & polymers

		Contaminant																
		ABS	EP	HIPS	PA	PBT	PC	PE	PET	PMMA	POM	PP	PS	PUR	PVC	SAN	PC+ABS	PC+PBT
Main plastic	ABS	G	O	Y	R	O	G	R	O	O	O	R	R	Y	Y	R	G	Y
	EP	Y	G	Y	Y	Y	Y	Y	Y	Y	Y	Y	Y	Y	Y	Y	Y	Y
	HIPS	Y	Y	G	R	R	R	R	R	R	R	R	O	R	R	R	R	R
	PA	R	R	O	G	O	R	R	O	R	R	R	O	O	R	R	R	R
	PBT	O	R	R	O	G	G	R	R	R	R	R	O	R	R	O	G	
	PC	G	O	O	R	G	G	R	G	G	R	R	R	O	O	G	G	G
	PE	R	R	R	R	R	R	G	R	R	R	G	R	R	R	R	R	R
	PET	O	R	O	O	R	G	R	G	R	R	R	O	O	R	R	O	R
	PMMA	O	R	O	R	R	G	R	Y	G	O	R	O	O	G	G	G	R
	POM	R	R	R	R	O	R	R	R	R	G	R	R	R	R	R	R	R
	PP	R	R	R	R	R	R	O	R	R	R	G	R	R	R	R	R	R
	PS (H)	R	R	O	R	R	R	R	R	R	R	R	G	R	R	R	R	R
	PUR	Y	R	O	Y	O	O	O	O	O	O	O	O	O	G	Y	O	O
	PVC	Y	R	R	R	R	R	R	R	G	R	R	R	O	G	G	O	R
	SAN	G	O	R	R	R	G	R	R	G	R	R	R	Y	G	G	G	O
	PC+ABS	G	O	G	R	G	G	R	Y	G	R	R	G	Y	O	G	G	G
	PC+PBT	G	O	R	O	G	G	R	Y	R	R	R	R	O	R	G	G	G

G	Good compatibility (properties stay good even if >5% contamination)
Y	Reasonable compatibility (properties stay good only if contamination <5%)
O	Limited compatibility (properties stay good only if contamination <2%)
R	Bad compatibility (properties are bad even if contamination =1%)

Source: [Peters, cited in Haarmann 2016]

#### 4.1.5. Degradation during use

During use plastics tend to degrade i.e. their polymer chains break. Short chains act like plasticizers. This is one of the reasons why plastic processors almost always add virgin plastic. They typically start with 100% virgin material and then replace it with recyclate until the material properties decrease to an unacceptable value.

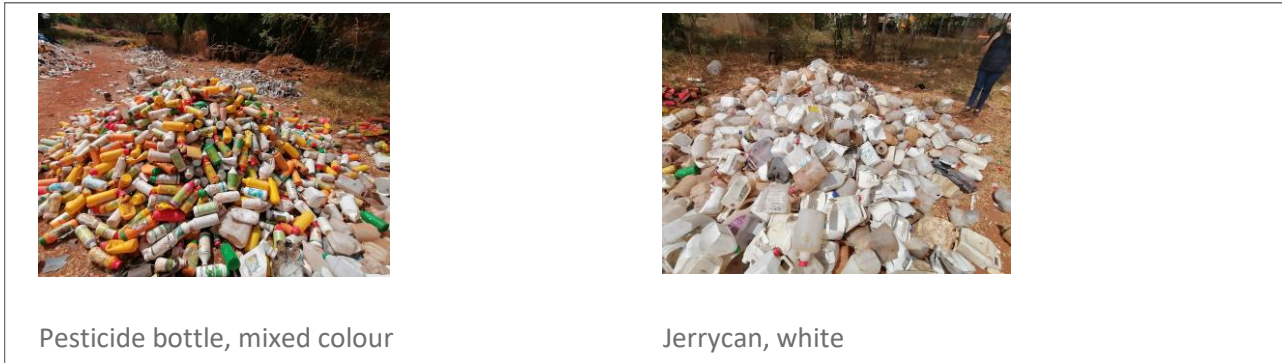
#### 4.1.6. Mixing of grades of polymers

Depending on the type of application the mechanical and thermal properties are adjusted. The MFR for example is different for big and for small or for thin-walled and thick-walled products. A common way to get around that fact is to simply sort the plastics not only to their type and possibly colour but also to their specific application. The fotos below show pesticide bottles of mixed colour (they still need to be sorted) and white jerrycans.



Collecting according to grade of polymer adds value to the recyclate. However, it needs strong quality management, trained workers and an excellent cooperation between aggregators and recyclers.

**Figure 4-2: Sorting according to type, application and colour**



## 4.2. Mechanical processing

The most important methods for mechanical processing are described in chapter 5.

## 4.3. Sorting

A simple method for sorting is according to the label. The following figure gives an example of a theoretical labelling.

**Figure 4-3: Sorting according to label: complete labelling of a plastic type**

>PP-GF30-P(ELO)FR(52)<

ISO 1043 part 1  
(base material - polymer)

ISO 1043 part 2  
(fillers)

ISO 1043 part 3  
(plasticizers)

ISO 1043 part 4  
(flame retardants)

Table 3: ISO 1043 codes for commonly used flame retardants (ISO, 1998). Codes which indicate BFRs are listed in bold, codes which may contain POP-BFR not common in WEEE (HBCD) in orange, codes which may contain RoHS / POP-BFRs in red.

Type	Code	Description
Halogenated compounds	<b>14</b>	aliphatic/alicyclic brominated compounds
	<b>15</b>	aliphatic/alicyclic brominated compounds in combination with antimony compound
	<b>16</b>	aromatic brominated compounds (excluding brominated diphenyl ether and biphenyls)
	<b>17</b>	aromatic brominated compounds (excluding brominated diphenyl ether and biphenyls) in combination with antimony compounds
	<b>18</b>	polybrominated diphenyl ether
	<b>19</b>	polybrominated diphenyl ether in combination with antimony compounds
	<b>20</b>	polybrominated biphenyls
	<b>21</b>	polybrominated biphenyls in combination with antimony compounds
	<b>22</b>	aliphatic/alicyclic chlorinated and brominated compounds
	<b>25</b>	aliphatic fluorinated compounds
Nitrogen compounds	30	nitrogen compounds (confined to melamine, melamine cyanurate, urea)
Organic phosphorus compounds	40	halogen-free organic phosphorus compounds
	41	chlorinated organic phosphorus compounds
Inorganic phosphorus compounds	<b>42</b>	brominated organic phosphorus compounds
	50	ammonium orthophosphates
	51	ammonium polyphosphates
Metal oxides, metal hydroxides, metal salts	52	red phosphorus
	60	aluminium hydroxide
	61	magnesium hydroxide
	62	antimony(III) oxide

Source:

Some mould manufacturers use labels that can be changed by turning an indicator. What seems like a good idea turn out to be a problem in practice. When raw materials are changed during manufacturing it is a tendency that changing the label is simply forgotten. Therefore, it is highly advisable not to rely on the labelling.

**Figure 4-4: Sorting according to label: labels and typical labelling on back of appliance**



Source:

#### 4.3.1. Hand sorting by application

Sorting according to application is one of the best methods to separate the WEEE plastics. The following graph gives examples of the most common applications.

**Figure 4-5: Most common items in WEEE and the main plastics component**

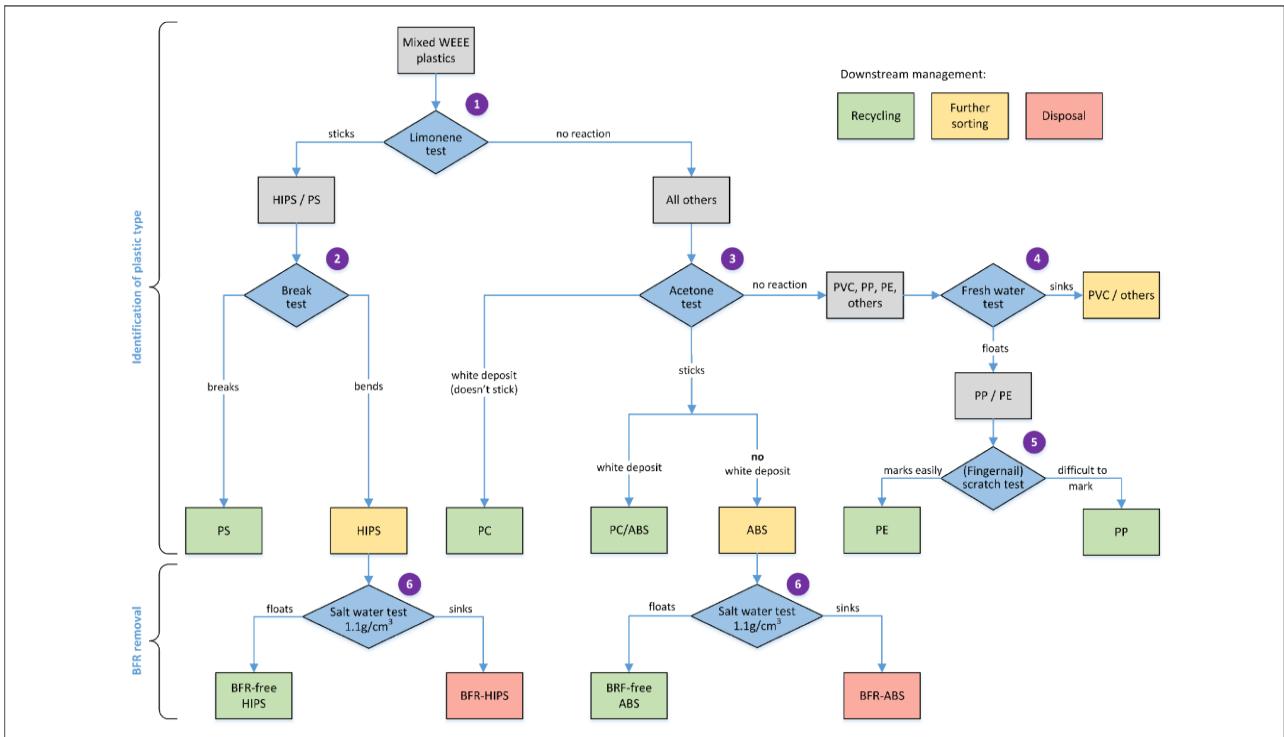


Fotos: GIZ E-waste treatment manual

### 4.3.2. Hand sorting with solvents

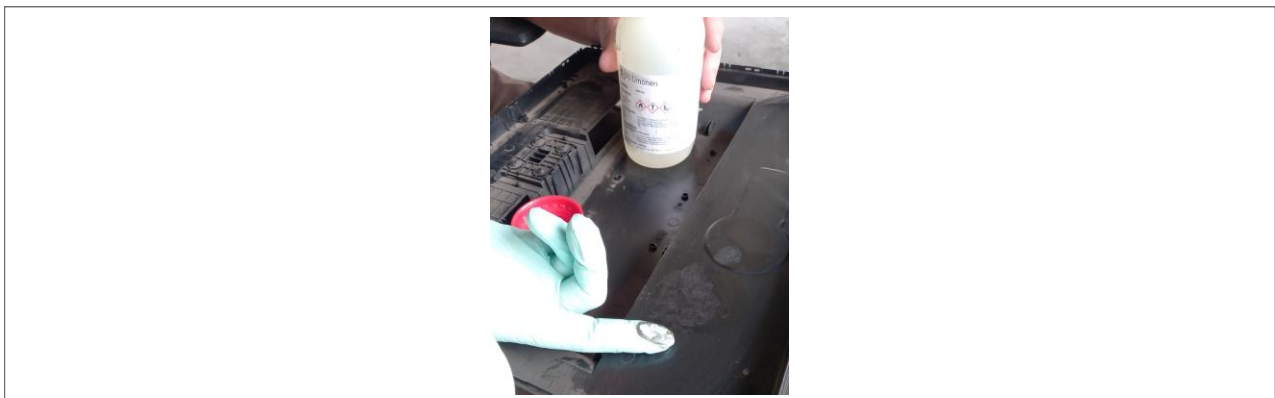
The limonene test is a common test in identifying ABS and HIPS. The method has been published extensively, e.g. [Bill 2019]. We call it here the SRI method. Once materials have been sorted according to their application it seems not really necessary to us to use the complete scheme but rather only the limonene test. Limonene dissolves HIPS but not ABS. Therefore, HIPS becomes sticky while ABS does not.

**Figure 4-6: Hand sorting with the procedure proposed by SRI [Bill 2019]**



Source: [Bill 2019], SRI

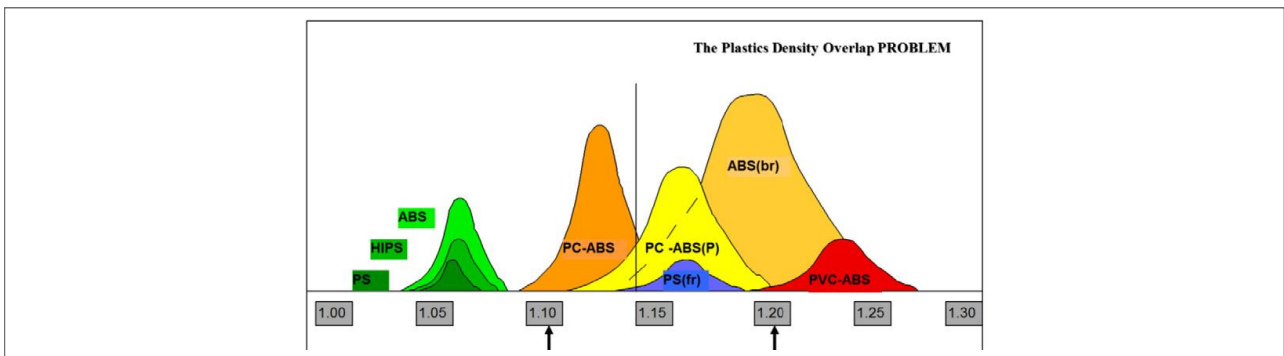
**Figure 4-7: Hand sorting with the limonene test: HIPS becomes sticky**



#### 4.4. Float-Sink separation

The most important separation method after the limonene test is float-sink separation. The graph below shows the densities of different plastics. After separation of ABS and HIPS unwanted fractions like those with brominated flame retardents can easily be removed. The removal of PE and PP is automatically included since it is necessary to clean the flakes with pure water. This will automatically bring those polyolefines to float while the WEEE plastics sink. It is possible to get fractions of HIPS, ABS and PC-ABS by using different densities, i.e. salt solutions for separation.

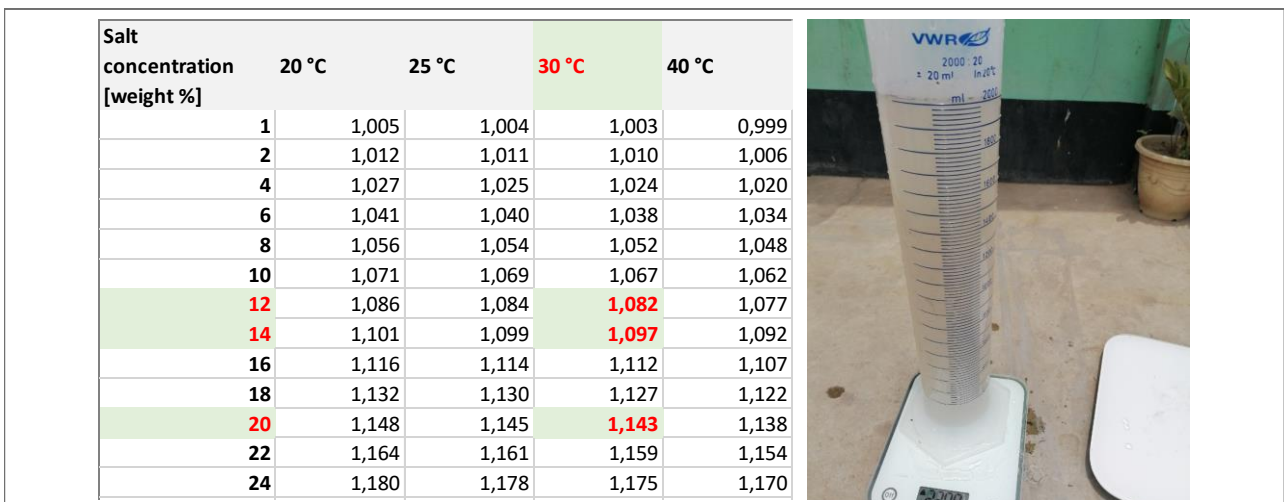
**Figure 4-8: Sorting with the float-sink method, removal of BFRs**



Source: Kobler and Voss, 2004

A density of 1.080 to 1.100 kg/l is sufficient to get a clean depolluted ABS. To adjust the density to 1.08 at 30°C ambient temperature a 12 weight percent solution is needed. 12 kg of sea salt are mixed with 88 kg of water. The exact density should be checked with a measuring glass and a scale. 1 l of solution should have a density of 1.080 or 1.100 kg/l. This should be checked on a daily basis.

**Figure 4-9: Density adjustment of salt solution for float-sink separation**





Source:

---

Salt can be readily obtained on the market in small quantities or in 100 kg sacks.

---

**Figure 4-10:** Salt for density adjustment can be bought on the market (March 2022: one sack with 100 kg = GHS 110.-)



Source:

---

#### **4.5. Washing and label removal**

Washing and label removal is crucial. It is common to clean plastics with washing detergent and baking soda. Labels are being removed by hand with a kitchen knife. Alternatively or additionally flakes can be washed in a concrete mixer. Additionally to cleaning the surface, the flakes hit each other and scrape off the labels by their impact and friction.

#### **4.6. Drying**

Drying is done in the open on clean blankets. The area where cleaning takes place should be dust free. As a final means of quality control the flakes should be sieved with a fine net to remove any dust particles and fines from processing.

#### **4.7. Extrusion**

Since there still can be particles present the use of a melt filter after the extruder is highly recommended.

## **4.8. Environmental impacts**

### **4.8.1. Leaching and migration of additives (e.g. brominated flame retardants)**

Some additives in plastics are listed in the Stockholm Convention on Persistent Organic Pollutants (POPs). Examples are brominated flame retardants (BFRs) like Polybrominateddiphenylethers (PBDEs). Others are the softening agents in PVC. Typically, they are phtalates. POPs are organic chemical substances that persist in the environment, bioaccumulate through the food chain and pose a risk of causing adverse effects to human health.

WEEE plastics with BFRs have a density > 1.10 an can be separated by density.

### **4.8.2. Byproducts from incineration or burning**

During uncontrolled burning at low temperatures substances like dioxines, furans, hydrochloric acid and other extremely toxic substances are being formed. Uncontrolled burning must therefore be reduced to a minimum.

## **4.9. Handling of material that cannot be recycled**

### **4.9.1. Landfill**

There is a small number of landfills available in Ghana. There is often only little protection of water leaking into the ground. Frequently they accidentally catch fire. Thus, landfill is not really an alternative. Also, it is not applicable to BFR containing plastics.

### **4.9.2. Incineration facilities (Takoradi, Municipal oven facilities (hospitals))**

There is only one waste incineration facility in Ghana located in Takoradi. It consists of a rotary kiln incinerator with a diameter of about 1.50 m and a length of about 6m. The offgases are scrubbed by state of the art technology. The facility is designed to incinerate wastes coming from the mining as well as from the oil industry. It is rather unlikely that this facility can manage the waste stream coming from WEEE recycling.

In some places in Kumasi scrapyards operators have set up their own incineration facilities by using barrels for the incineration chamber as well as for the chimney. This can be seen as a first improvement compared to open burning in smoldering fires with low temperatures.

As a medium term solution the use of local incineration facilities like they are used in hospitals to dispose of hygienic waste could be considered. Of course there is no gas scrubbing present. On the other hand due to the draft in the chimney incineration takes place at high temperatures, reducing the formation of extremely poisonous substances considerably. Therefore, this can be considered as a medium term solution.

**Figure 4-11:** Incineration facility in Vume, Volta region (left), uncontrolled burning on the former scrapyards of Agbogbloshie



#### **4.9.3. Steel works and cement industry**

In Europe it is very common to use used tires as a fuel in the cement industry. Off course in this case the steel wires from the inside cannot be recovered. Also operators are anxious about the specification of their final product which poses additional hurdles. Using uncontrolled waste streams in this case is just too critical.

The steel industry can be seen as a possible user of plastic flakes as fuel. Since they have a particle size that can be easily handled this option should be further investigated.



## 5. WEEE plastics and value chain for recycling

### 5.1. WEEE plastics in Ghana

#### 5.1.1. Types and applications in WEEE

Typically, WEEE contains of about 20-30% plastics. According to the WEEE Forum in 2020 a total amount of 53.6 million tonnes of WEEE were disposed of in the world. The plastics in this stream therefore amount for between 10.7 and 16.1 million tonnes. In 2015 407 million tonnes of plastics were produced. A major portion of these material end up as waste.

In Ghana, the amount of WEEE being used is 53.000 tonnes per year. The plastic content is between 10,600 and 15,900 tonnes per year. Currently no recycling of these materials takes place. In comparison: Ghana disposes of some 1.1 million tonnes of plastics per year. This is mainly post-consumer packaging waste. It is estimated that 5-10% or 55,000 to 110,000 tonnes per year are recycled.

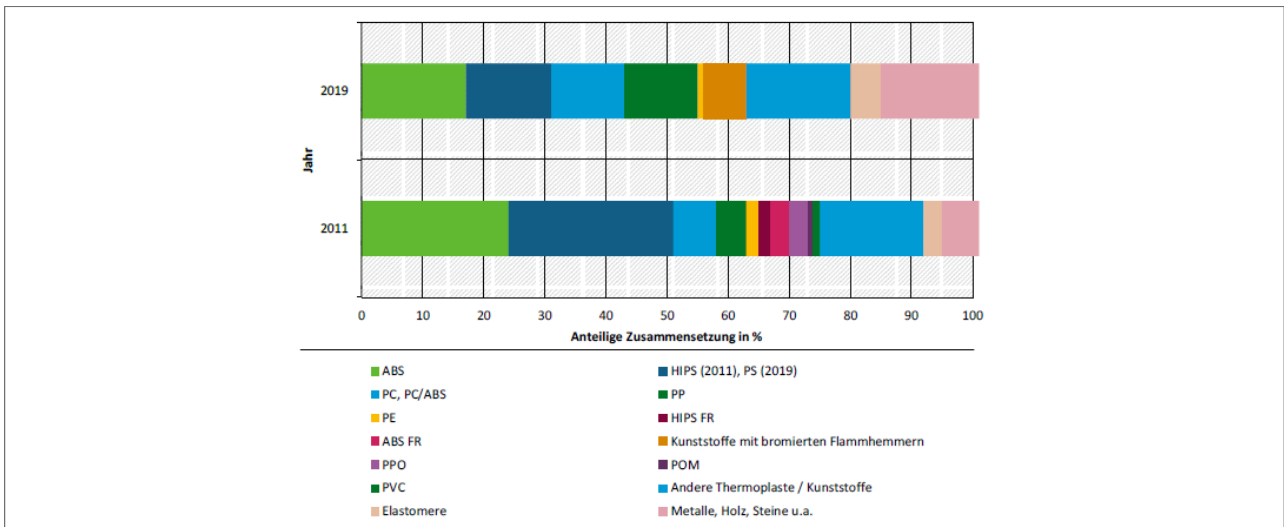
Therefore, for consumer plastics as well as for WEEE plastics there is a high potential for recycling or in other words: for a growing recycling industry in Ghana there is a huge stream of „raw material“ available.

The main polymers beeing present in WEEE plastics are:

- ABS
- HIPS/ PS
- PC (polycarbonate), PC/ABS blends
- PP
- PE
- HIPS FR
- ABS FR
- Plastics with BFRs
- PPO (polyphenyleneoxide)
- POM (Polyoxymethylene)
- PVC
- Other thermoplastics
- Elastomers/ rubber
- Metal, wood, stones

The composition of WEEE plastics change considerably over the years. A good example is the banning of BFRs and the change of requirements for new applications like lithium-ion battery casings. This has led to the increased use of ABS/PC blend and thus a shift in the composition of WEEE plastics. While the percentage of ABS and HIPS have decreased, the amount of PC/ABS and PP has markedly increased.

**Figure 5-1: Composition of WEEE plastics sampled at mgg-polymers**



Source: Einsatz von Post-Consumer- Recycling-Kunststoffen in energieverbrauchsrelevanten Geräten, Report 24/2021, German Federal Environmental Agency (UBA)

According to these numbers it is most promising to concentrate recycling activities on:

- ABS
- HIPS
- PC/ ABS
- PP

Assuming that ABS and HIPS comprise some 30% of the WEEE plastics and that 50% can be collected, there is a potential for WEEE plastics recycling of 1,500 -2,250 tonnes of these plastics per year.

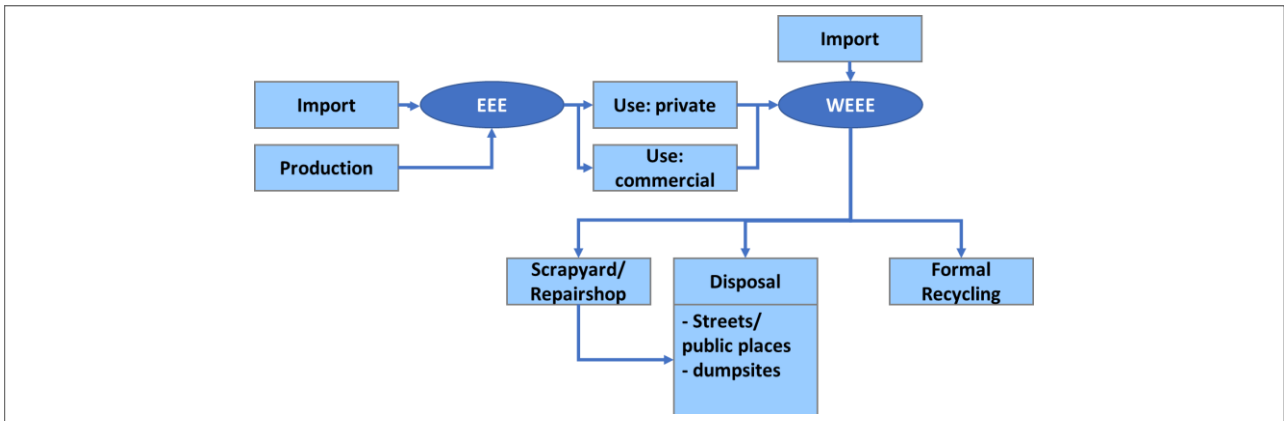
## 5.2. Recycling value chain

To understand the plastics-recycling value chain it is worth looking at WEEE plastics recycling and post consumer plastics first.

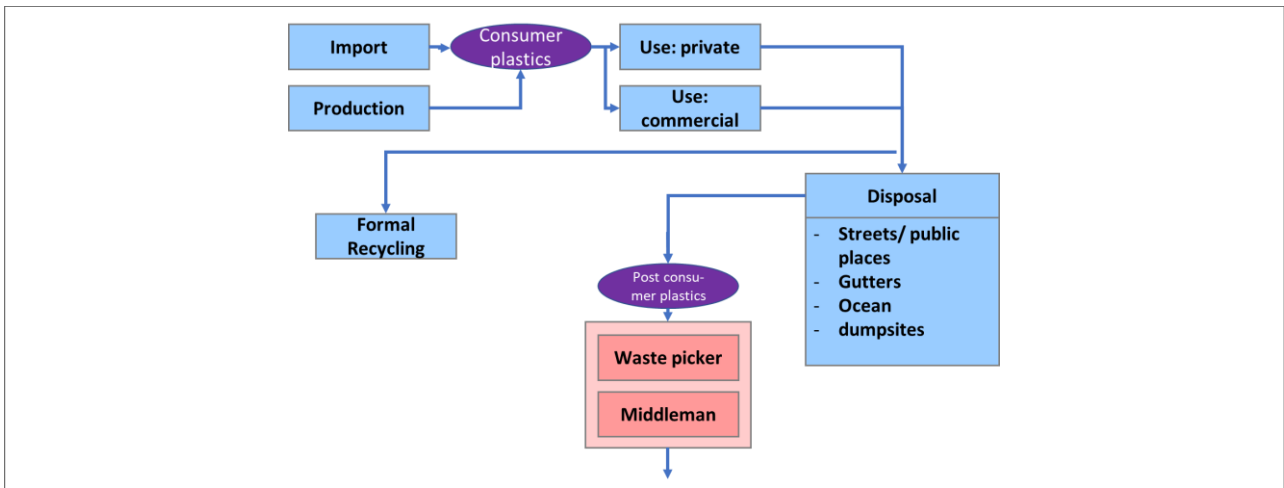
### 5.2.1. WEEE plastics and post-consumer plastics

Currently, the plastics from WEEE do not find any use. In principle the collection system started recently by MEST-PIU has the objective of supporting and building up of a formal recycling industry. However, currently there is no active recycling industry in this field. Therefore, the leftovers of the scrapyards and repair shops end up in the various disposal sites or are burned.

**Figure 5-2: Material flow of Electrical and Electronic Equipment (EEE) and Waste EEE (WEEE) in Ghana**

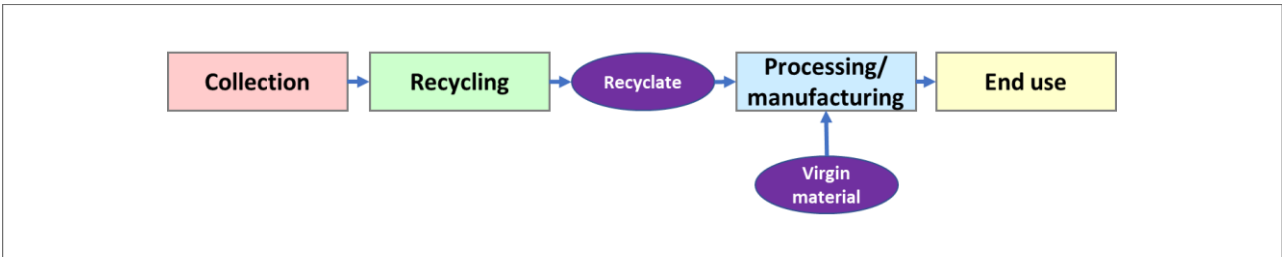


**Figure 5-3: Material flow of Consumer Plastics and Post Consumer Plastics in Ghana**



A different picture gives the recycling of post consumer plastics. Even though the recycling quota is still low an industry has developed for collection and recycling. Plastic processors are happy to use recycle to substitute expensive virgin material (Figure 5-4, Figure 5-5).

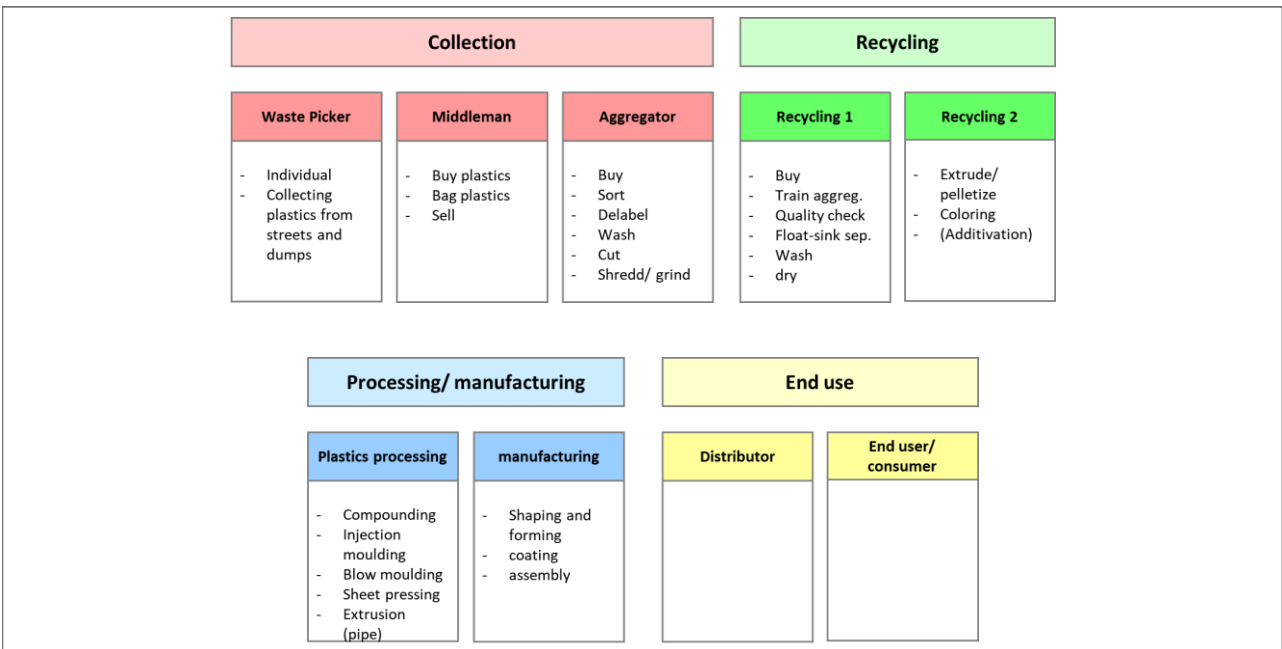
**Figure 5-4: Post Consumer Plastics Recycling in Ghana: overview of value chain**



Collection is being done either by individuals delivering the plastics directly to aggregators or, as is typical in Ghana, by middlemen or by the aggregators themselves who drive through the towns with tricycles to collect plastic waste. The aggregators buy, sort, delabel, wash, cut and shred the plastic.

The recyclers which are typically the plastic processors themselves buy the material, do quality control of the incoming streams (e.g. by floating to get rid of unwanted components like stones or other plastics), wash and dry. Then the material is extruded/ pelletized and later mixed in the plastics processing steps. Currently there is hardly any attempt to export flakes or pellets to outside of Ghana.

**Figure 5-5: Post Consumer Plastics Recycling in Ghana: value chain**



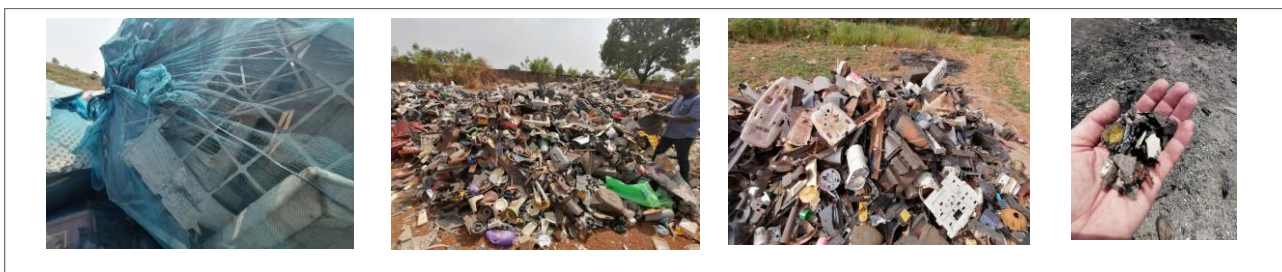
The collectors are not trained and also they want to receive enough money to make their living. As a result, they collect „hard plastics“ and do not care weather they collect HDPE, PP or ABS and HIPS. Table 5-1 gives an overview on these methods. Only water sachets made of LDPE do not go that route.

**Table 5-1: Plastic types and current status of collection and recycling**

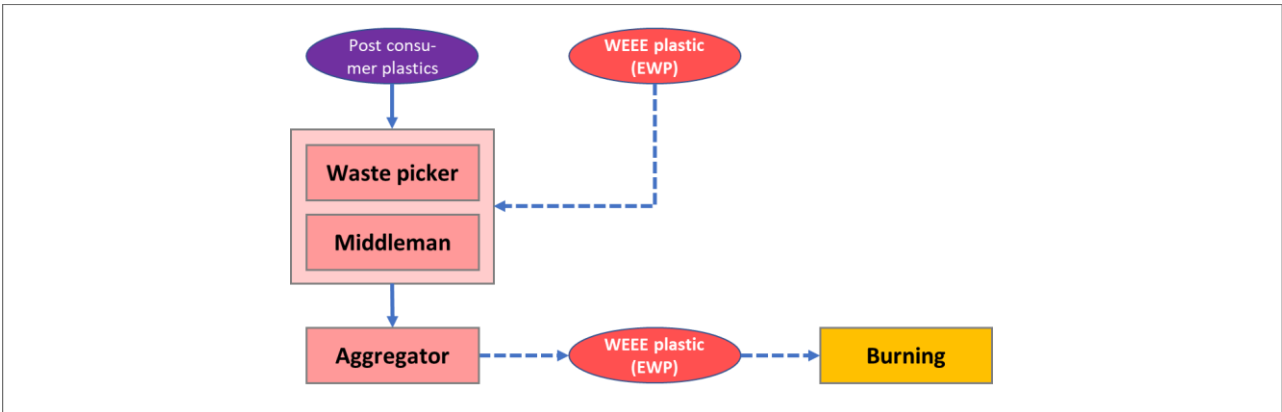
plastic	Use/ identification	category	recycling common?	Current process	collection by
<b>Post consumer plastics</b>					
LDPE	Sachet	soft plastic	yes	mechanical recycling, burning	waste picker, middleman
HDPE	Bottle/ gallon	hard plastic	yes	mechanical recycling, burning	waste picker, middleman
PP	Chair	hard plastic	yes	mechanical recycling, burning	waste picker, middleman
PET	Water bottle	hard plastic	yes	mechanical recycling, burning	waste picker, middleman
<b>E-waste plastics (EWP)</b>					
HIPS		hard plastic	no	burning	no collection, (MEST PIU)
ABS		hard plastic	no	burning	no collection, (MEST PIU)
ABS/ PC		hard plastic	no	burning	no collection, (MEST PIU)
ABS/ PET		hard plastic	no	burning	no collection, (MEST PIU)
PC		hard plastic	no	burning	no collection, (MEST PIU)
PMMA	LCD monitors	hard plastic	no	burning	no collection, (MEST PIU)
<b>Cables</b>					
PVC	cable	cable	no	burning	no collection, (MEST PIU)
HDPE/ LDPE	cable	cable	no	burning	no collection, (MEST PIU)
Elastomers	cable	cable	no	burning	no collection, (MEST PIU)

On the collection yards of the aggregators there are commonly huge piles of “black plastics” with no current use. The solution is obvious: unwanted material is simply burned directly on site or closeby giving the usual problems of emitting biting smoke. During washing the light polyolefines (PE, PP) will float, while other material will sink. This material is called “the under” and is typically burned at the side. Most likely valuable materials are burned that could be made use of (Figure 5-6, Figure 5-7).

**Figure 5-6: Collection of “hard plastics”, piling of “non-usable plastics” and burning**



**Figure 5-7: WEEE plastics collected during recycling of post consumer plastics are being burned**

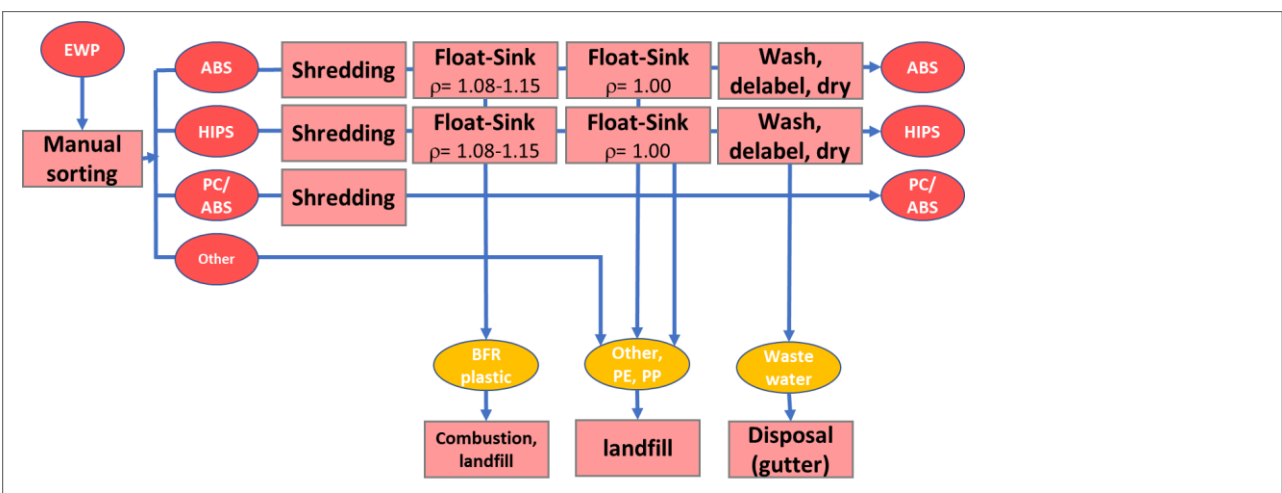


**5.2.2. Value chain by technologies**

There are two principle routes for recycling of WEEE plastics: “manual route” and the “machine route.”

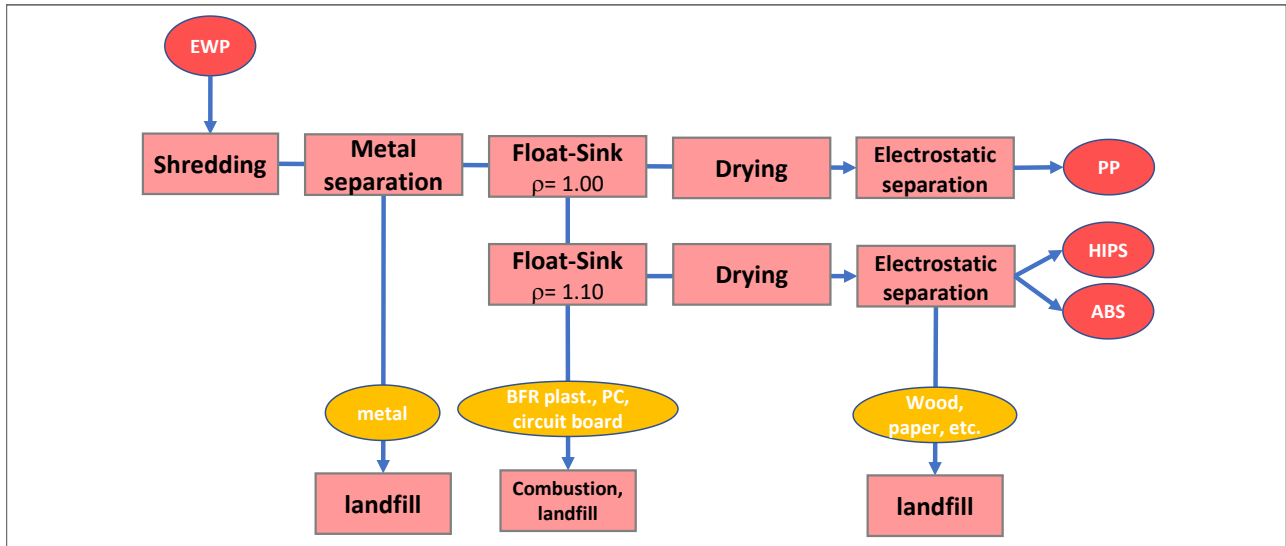
With the methods described in previous chapters it is possible to separate ABS, HIPS and possibly ABS/PC by hand. PP is in most cases already collected and processed. This manual sorting can be very effective. After shredding in rotary knife shredders (“crushing”) the next step is float-sink separation in water basins with a high salt content to adjust the density to a value of 1.08 kg/l. After that washing with baking soda and water takes place. During that washing the -in this case - unwanted polyolefines will float. Final washing with pure water is done before drying in the open sun (Figure 5-8).

**Figure 5-8: Value chain for recycling of WEEE plastics: hand sorting (“manual route”)**

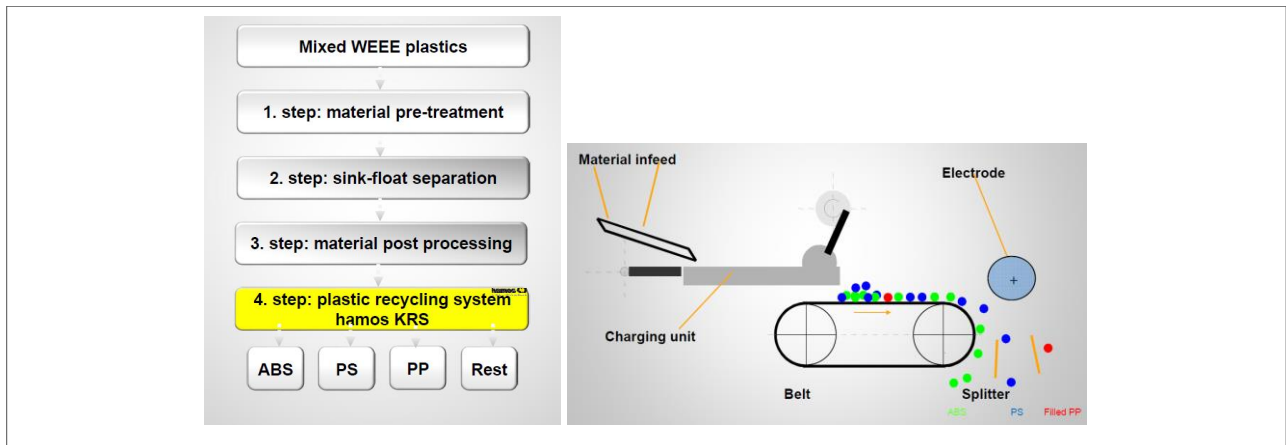


Due to the high cost of labour in the industrialized countries separation of plastic types and removal of BFRs by float-sink separation are done recersely. The process starts with shredding of the whole WEEE items followed by metal separation. Two float-sink steps yield a polyolefin fraction and a BFR free HIPS – ABS fraction. Those fractions are then separated into the pure polymer streams. Wood and paper is removed at the same time.

**Figure 5-9: Value chain for recycling of WEEE plastics: technical version (“machine route”)**



**Figure 5-10: WEEE plastics recycling: “machine route” with electrostatic separation**



Source: hamos GmbH Recycling- und Separationstechnik, Germany

**Figure 5-11: “Machine route”: state of the art WEEE plastics recycling plant**



Source: hamos GmbH Recycling- und Separationstechnik, Germany

---

It is worth understanding this route because exporting of ABS and HIPS flakes to industrialized countries is a principle option. In case of insufficient purity such flakes could still be fed into such a process before the electrostatic separation step to give the material the final purity.

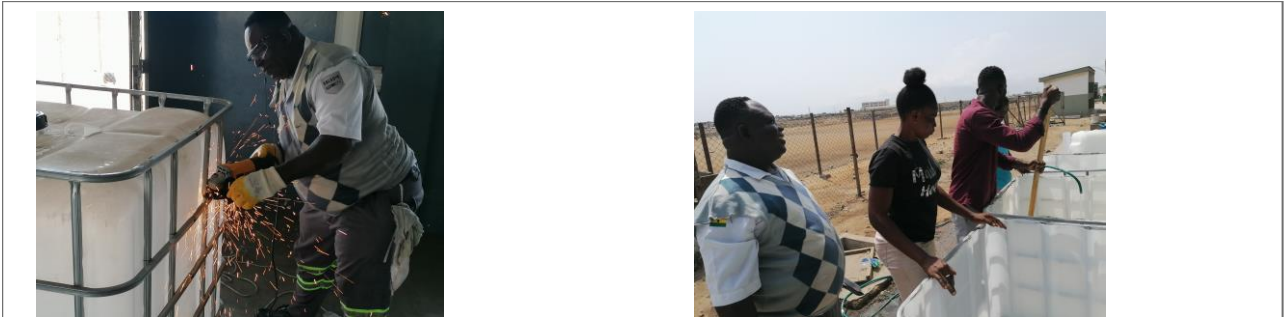


### 5.3. GIZ Pilot facility and properties of WEEE recyclates

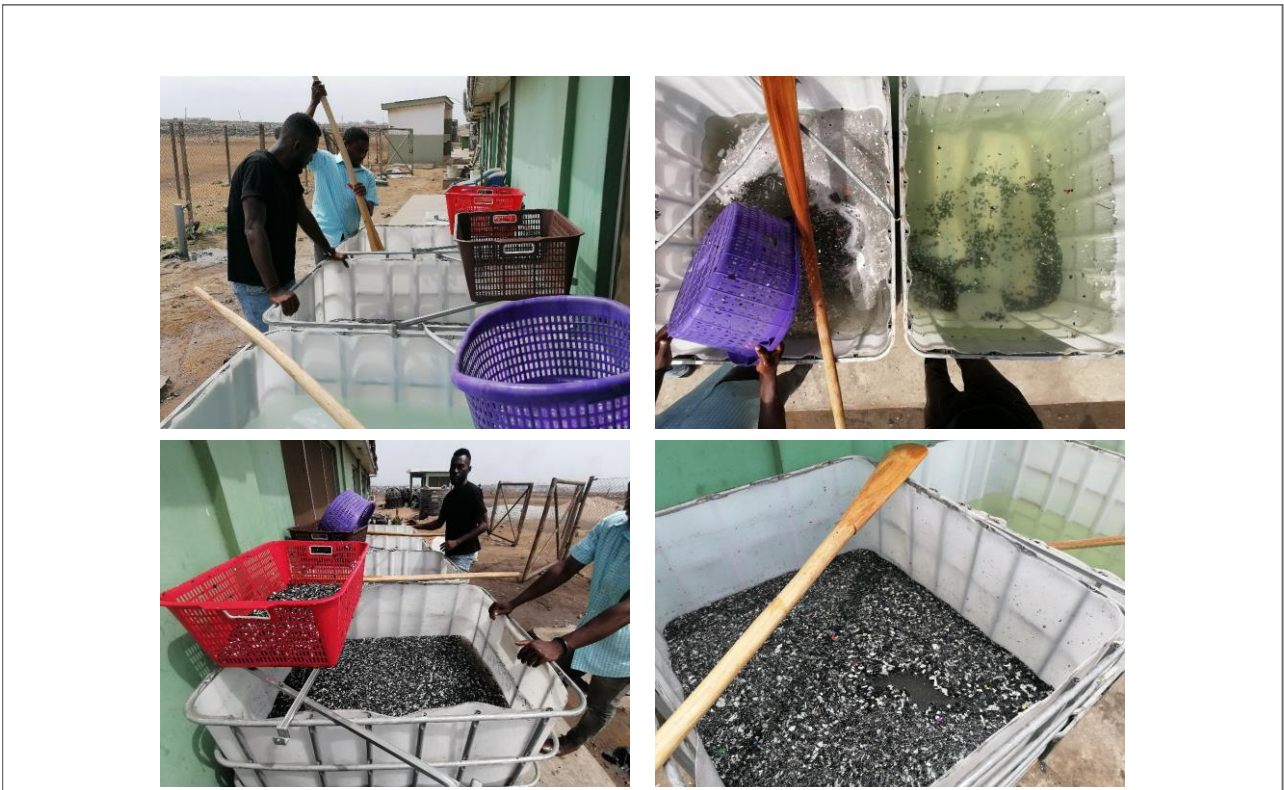
#### 5.3.1. Pilot facility at TTC

In order to test the proposed separation process and to generate samples for investigation of quality and material properties, a pilot facility was built at the Technical Training Center (TTC) operated by MESTI/ GIZ E-Waste programme.

**Figure 5-12: Float-Sink basins at TTC made from used Intermediate Bulk Containers (IBCs)**



**Figure 5-13: Float-Sink basins at TTC**



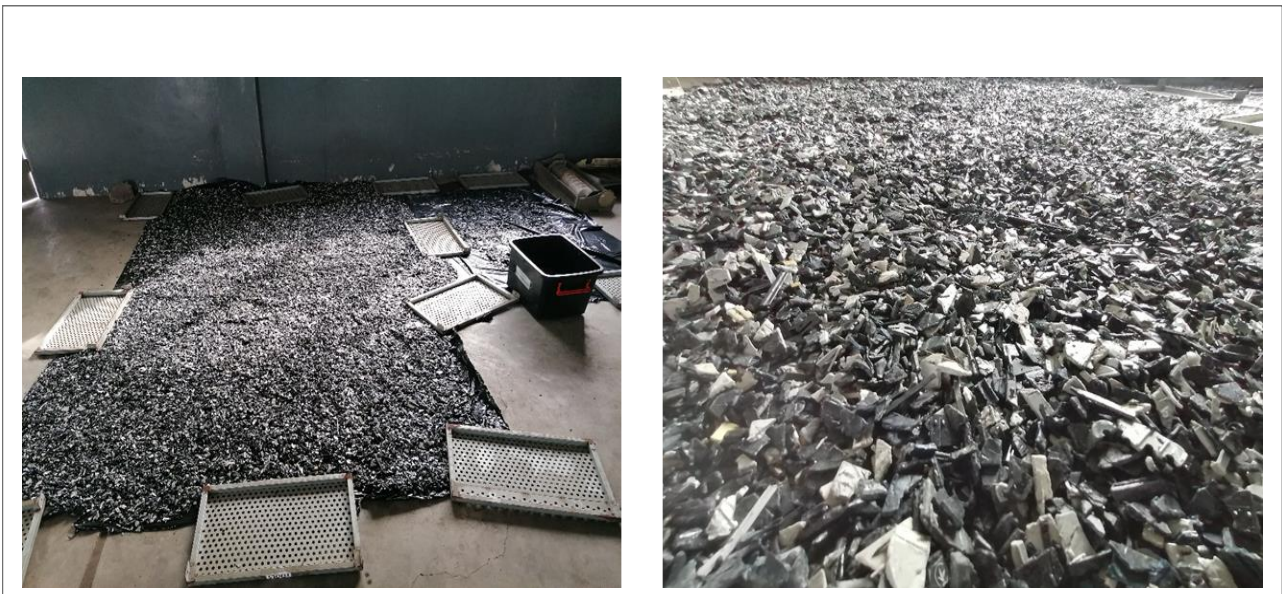
The core units are four float-sink vessels for density separation as well as cleaning of the separated plastics. Four intermediate bulk containers were cut open. They were filled with

- 1) Saltwater solution with density 1.140 kg/m<sup>3</sup>
- 2) Saltwater solution with density 1.100 kg/m<sup>3</sup>
- 3) Water with dissolved baking soda and washing powder
- 4) Pure water for cleaning

In this unit crushed plastic flakes are suspended in the solutions and are agitated with long wooden spoons. The flakes floating are collected with washing baskets and are then transferred to the next IBC. The cleaning is done with baking soda and washing powder which is common in plastics recycling. Finally the flakes are cleaned with water. They are then placed on plastic film inside of the building for drying.

---

**Figure 5-14: Drying of recyclates on plastic film in the open air**



---

### 5.3.2. Pilot runs on ABS and HIPS

The recycling process starts with the collection and hand sorting. In a first run, flatscreens were collected and sorted according to their label. Several types of plastics were found with the majority being ABS:

- ABS
- ABS-PET
- ABS-PC
- HIPS
- Non identifiable

The non identifiable as well as the the ABS screens were then again checked for their identity by the limonene test. Most of the non identifiable fraction consisted of ABS. For HIPS housings of air conditioning systems were sorted and tested accordingly.

This material was then bagged and brought to the facility of two plastics aggregators. Close to Gomoa Dominase near Winneba on the Accra Takoradi Highway the onion market can be found that has been relocated from Agbogbloshie. Behind that onion market a number of plastics aggregators have opened their shops forming a “plastics hotspot”.

In two facilities ABS and HIPS were crushed in a shredder. These shredders are either self built or commercial rotating-blade shredders. With the help of a sieve with a hole size of about 10 mm the particle size was adjusted. After shredding the fine particles were removed with the help of a fishing net. The flakes were then bagged and brought to the pilot facility.

---

**Figure 5-15: Shredding and sieving of HIPS at the “plastics hotspot”**





Figure 5-16: Collection, sorting, shredding of ABS flatscreens



### 5.3.3. Material properties of ABS and HIPS recyclates

The properties of the samples were analyzed at the following institutions:

- a) Mgg Polymers, Austria (Mr. Chris Slijkhuis): Particle size, plastic type, dust and metal content
- b) Thüringisches Institut für Textil- und Kunststoff-Forschung (TITK), Rudoldstadt, Germany, Dr. S. Reinemann: MFR, mechanical properties
- c) SGS Institut Fresenius GmbH, Taunusstein, Germany Dr. S. Graß: BFR content

The following tables show the results of the analyses for three different samples:

#### 1) ABS 001

- ABS from flatscreens
- Handsorted by application, label and by limonene test
- Crushed with rotating blade shredder with sieve size 10 mm
- Density separated ( $0,995 \text{ kg/m}^3 < \rho < 1,10 \text{ kg/m}^3$ )
- Cleaned with aqueous solution of baking soda and washing detergent
- Cleaned with water
- Dried on plastic film in the open for 2 days

Figure 5-17: ABS flakes sample ABS 001



Source: mgg-polymers, SGS Institut Fresenius

#### 2) ABS 002

- ABS from flatscreens
- Handsorted by application, label and by limonene test
- Crushed with rotating blade shredder with sieve size 10 mm
- Density separated ( $1,10 \text{ kg/m}^3 < \rho < 1,14 \text{ kg/m}^3$ )
- Cleaned with aqueous solution of baking soda and washing detergent
- Cleaned with water
- Dried on plastic film in the open for 2 days

**Figure 5-18: ABS flakes sample ABS 002**



Source: SGS Institut Fresenius

### 3) HIPS 001

- ABS from flatscreens
- Handsorted by application, label and by limonene test
- Crushed with rotating blade shredder with sieve size 10 mm
- Density separated ( $0,995 \text{ kg/m}^3 < \rho < 1,10 \text{ kg/m}^3$ )
- Cleaned with aqueous solution of baking soda and washing detergent
- Cleaned with water
- Dried on plastic film in the open for 2 days

**Figure 5-19: HIPS flakes sample HIPS 001**



Source: mgg-polymers, SGS Institut Fresenius




**Table 5-2: Composition and particle-size distribution sample ABS 001**

Anteil [g]	%		Anteil [g]	%		Anteil [g]	%	
Kunststoffe:	1 004,00	98,10	Reststoffe:	0,00	0,00	nicht sep. Feinanteil:	21,48	2,10
Gummi:	0,00	0,00	Schaum/Flusen:	0,39	0,04	KS ≤1,0 g/cm3:	72,20	7,05
Aluminium:	0,00	0,00	Holz n. behandelt:	0,00	0,00	KS >1,00 bis ≤1,07 g/cm3:	865,40	84,55
Eisen:	0,00	0,00	Holz behandelt:	0,02	0,00	KS >1,07 bis ≤1.2 g/cm3:	64,00	6,25
Kupfer:	0,00	0,00	Glas:	0,00	0,00	KS ≥1,2 g/cm3:	0,00	0,00
Kabel/-isolierung:	0,00	0,00	Steine:	0,00	0,00	Probemenge:	1 023,49	
goldhaltige Bauteile:	0,00	0,00	Sonstiges:	0,00	0,00			

PP %	PS %	ABS %	PCABS %	PE %
0,51	1,46	80,05	0,00	0,53




Source: mgg-polymers

**Table 5-3: Composition and particle-size distribution sample HIPS 001**

Anteil [g]	%		Anteil [g]	%		Anteil [g]	%	
Kunststoffe:	977,30	96,79	Reststoffe:	0,25	0,02	nicht sep. Feinanteil:	12,33	1,22
Gummi:	0,00	0,00	Schaum/Flusen:	12,71	1,26	KS ≤1,0 g/cm3:	68,10	6,74
Aluminium:	0,13	0,01	Holz n. behandelt:	0,00	0,00	KS >1,00 bis ≤1,07 g/cm3:	826,80	81,88
Eisen:	3,31	0,33	Holz behandelt:	0,00	0,00	KS >1,07 bis ≤1.2 g/cm3:	74,20	7,35
Kupfer:	0,00	0,00	Glas:	0,00	0,00	KS ≥1,2 g/cm3:	5,90	0,58
Kabel/-isolierung:	0,00	0,00	Steine:	0,00	0,00	Probemenge:	1 009,75	
goldhaltige Bauteile:	0,00	0,00	Sonstiges:	6,02	0,60			

PP %	PS %	ABS %	PCABS %	PE %
0,23	86,47	0,87	0,01	0,14



Source: mgg-polymers

Table 5-2 and Table 5-3 give the results for the investigation of the quality of the materials ABS 001 and HIPS 001. In both cases there are traces of metal and foam. The purity of the respective polymers is more than 80% according to the analysis. It is assumed that the numbers are comparatively low since there are fillers like carbon black as well as other additives present in the polymer matrix.

Tensile bars were made by injection moulding at TITK. They were then used to determine the mechanical properties.

**Figure 5-20: Tensile bars made by injection moulding at TITK for ABS 001**



The results are given in Table 5-4. It shows the properties for ABS 001 and ABS 002 together with three commercial recyclates from mgg polymers as well as three commercial virgin grades from INEOS Styrolution.

**Table 5-4: Material properties of recyclates, commercial recyclates and virgin material**

	Standard	Units	ABS 001	ABS 002	MGG Polymers ABS C7400	MGG Polymers ABS C7500	MGG Polymers C7600	Styrolution Terluran GP-22	Styrolution Terluran HI-10	Styrolution Terluran GP-35
Physical			Recyclate	Recyclate	Recyclate	Recyclate	Recyclate	Virgin	Virgin	Virgin
Density		kg/cm <sup>3</sup>	995...1100	1100...1140	1060	1060	1170			
Rheological										
MFR 220°C/ 10 kg	ISO 1133	g/10min			24	26	23			
MFR 230°C/ 10 kg	ISO 1133	g/10min	41	1,7						
MVR 220°C/ 10 kg	ISO 1133	cm <sup>3</sup> /10min						19	5,5	34
MVR 230°C/ 10 kg	ISO 1134	cm <sup>3</sup> /10min	50,1	2						
Mechanical										
Tensile modulus	ISO 527	MPa	2510	2225	2200	2200	2250	2300	1900	2300
Tensile stress at yield	ISO 527	MPa	40,1	37	41	41	47	45	38	44
Stress at break	ISO 527	MPa	33,3	36,9	36	34	40			
Impact										
Charpy Impact strength notched	ISO 179	kJ/m <sup>2</sup>	11,6	1,9				22	35	19
Izod Impact strength notched	ISO 180	kJ/m <sup>2</sup>			13	19	28			
Description										
			ABS fraction	ABS-PC fraction+A3;K21	An easy flowing Post-Consumer Recycled (PCR) ABS Copolymer for general purpose applications.	An easy flowing Post-Consumer Recycled (PCR) ABS Copolymer with increased requirements for impact resistance.	An easy flowing Post-Consumer Recycled (PCR) Polycarbonate/ ABS Blend for general and high tech purpose applications.	ABS standard, Impact strength	ABS standard high impact strength	ABS standard, enhanced flow

For ABS 001 all properties are comparable to the commercial recyclates as well as to the commercial virgin material. That also applies for most of the properties of ABS 002. However, the impact strength is very low. This material comes from the density separation in the range of  $1,10 \text{ kg/m}^3 < \rho < 1,14 \text{ kg/m}^3$ . It is most likely



that it consist of ABS-PC blend. Also it is assumed that dust particles can be present thus influencing the material properties.

Finally the material was tested for the content of BFRs. Table 5-5 gives these results. No BFRs could be found at all. However it must be noted that the samples contain a considerable amount of Chlorine and Bromine. That can be in part explained by the separation process that uses concentrated salt solutions. This issue must definitely be addressed in the further development.

**Table 5-5: Analysis for brominated flame retardants for samples ABS 001, ABS 002 and HIPS 001**

Sample No.	Sample designation	Sample material
220789103	Sample No ABS 001	plastic
220789104	Sample No ABS 002	plastic
220789105	Sample No HIPS 001	plastic

**Analytical results**

**Halogens**

Parameter	Unit	220789103	220789104	220789105	RL
Chlorine (Cl)	mg/kg	110	1390 <sup>#</sup>	599 <sup>#</sup>	50
Bromine (Br)	mg/kg	299	n.d.	984	50

Note:  
 RL: report limit  
 n.d.: not detected  
<sup>#</sup>: increased analytical deviation due to sample matrix

**PBB/PBDE**

**Polybrominated Biphenyls(PBB) and Polybrominated Diphenyl Ethers (PBDE)**

Test results by chemical method (Unit: mg/kg)	220789103	220789104	220789105	RL
Sample No.	220789103	220789104	220789105	
<b>Sum of PBDEs</b>	-	-	-	-
Monobromodiphenyl ether	n.d.	n.d.	n.d.	10
Dibromodiphenyl ether	n.d.	n.d.	n.d.	10
Tribromodiphenyl ether	n.d.	n.d.	n.d.	10
Tetrabromodiphenyl ether	n.d.	n.d.	n.d.	10
Pentabromodiphenyl ether	n.d.	n.d.	n.d.	10
Hexabromodiphenyl ether	n.d.	n.d.	n.d.	10
Heptabromodiphenyl ether	n.d.	n.d.	n.d.	10
Octabromodiphenyl ether	n.d.	n.d.	n.d.	25
Nonabromodiphenyl ether	n.d.	n.d.	n.d.	25
Decabromodiphenyl ether	n.d.	n.d.	n.d.	50
<b>Summe PBBs / Sum of PBBs</b>	-	-	-	-
Monobromobiphenyl	n.d.	n.d.	n.d.	10
Dibromobiphenyl	n.d.	n.d.	n.d.	10
Tribromobiphenyl	n.d.	n.d.	n.d.	10
Tetrabromobiphenyl	n.d.	n.d.	n.d.	10
Hexabromobiphenyl	n.d.	n.d.	n.d.	10
Pentabromobiphenyl	n.d.	n.d.	n.d.	10
Heptabromobiphenyl	n.d.	n.d.	n.d.	10
Octabromobiphenyl	n.d.	n.d.	n.d.	25
Nonabromobiphenyl	n.d.	n.d.	n.d.	25
Decabromobiphenyl	n.d.	n.d.	n.d.	50

Note:  
 RL: report limit  
 n.d.: not detected

Source: SGS Institut Fresenius

In summary: the recycled material has excellent properties making it ready for industrial application.

#### 5.4. Guidelines for Handover Center and collectors

At the handover center of MEST-PIU in Old Fadama collection of WEEE plastics started in early 2022 (Figure 5-21). A representative sample of this material was analyzed and then returned.

**Figure 5-21: Collection of WEEE plastics at MESTI-PIU**



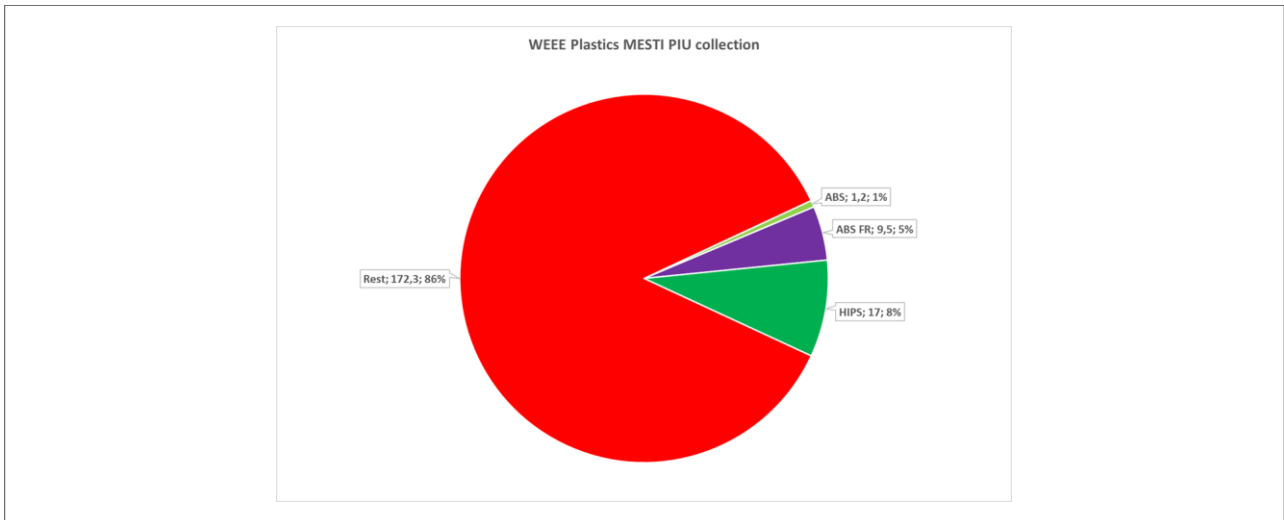
The first important observation was that the items were crushed to small pieces when delivered. This is due to the fact that the bulk density of crushed material is much higher than that of intact pieces. This makes sorting extremely labour intensive and should therefore be avoided. The analysis according to plastic type is shown below. Only few items consisted of the valuable fraction ABS and HIPS. Furthermore. There was a considerable amount of ABS with flame retardant present. A more detailed view was gained by sorting the items according to application. The main types of applications are:

- |                         |                    |
|-------------------------|--------------------|
| • Switchboards, meters: | Polycarbonate (GF) |
| • AC                    | HIPS               |
| • Small household items | ABS/ HIPS          |
| • Control cabinets      | PMMA Acrylic       |
| • Fans from motors      | Polyamide          |

It turned out that the largest fraction were old switchboard meters and control cabinets from old ECG meters. This is due to the fact that new meters were introduced recently and thus there are a lot of old meters in the system that were brought by one of the middlemen. Hence, this is only a snap-shot for the current situation but does not reflect a permanent situation.

---

**Figure 5-22: Analysis of WEEE plastics sample from MESTI-PIU**



**Figure 5-23: Sample of WEEE plastics**



**Figure 5-24: Sorting according to application**



Based on these results a closer look was taken at the collection model. Figure 5-25 shows the existing system. Middlemen bring the WEEE plastics to the handover center or the satellite handover center. After collection the material is being transported to a formal recycler.

**Figure 5-25: Collection model implemented by MEST-PIU (collection method I)**

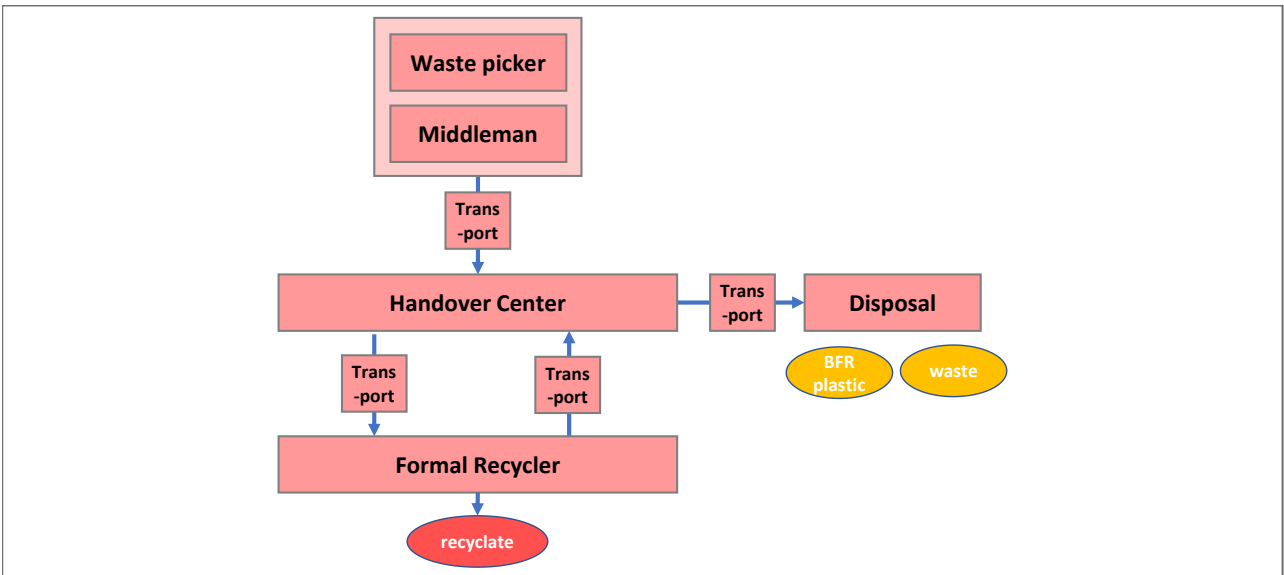
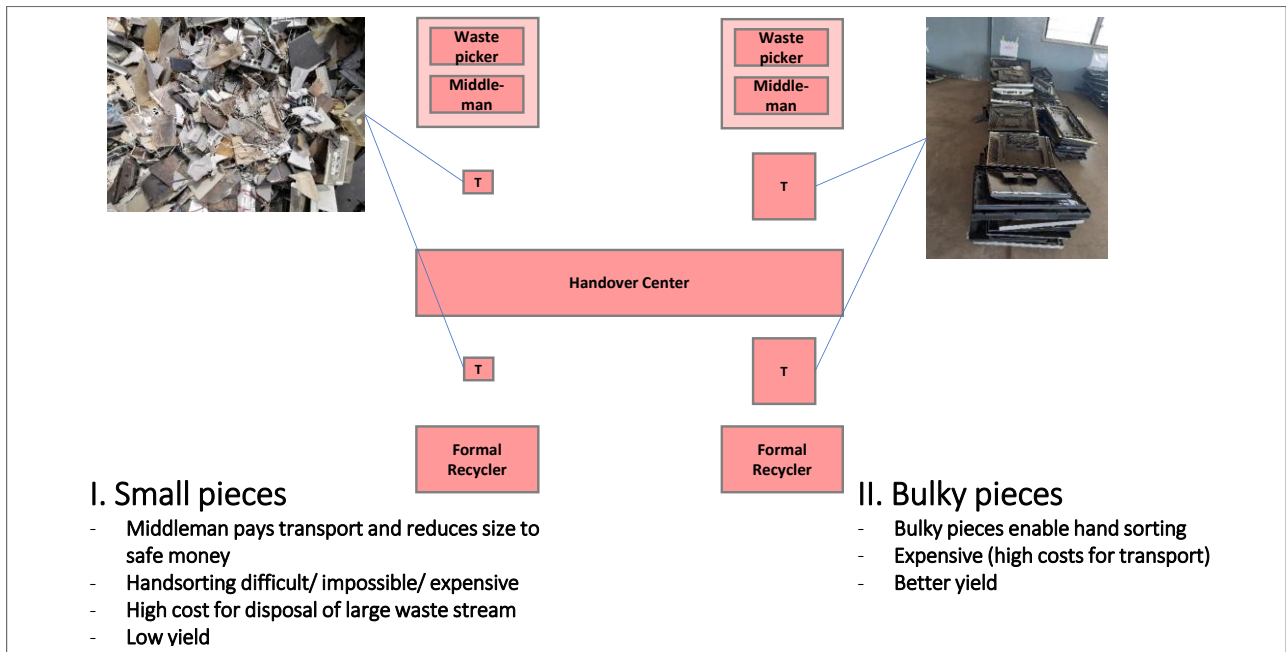


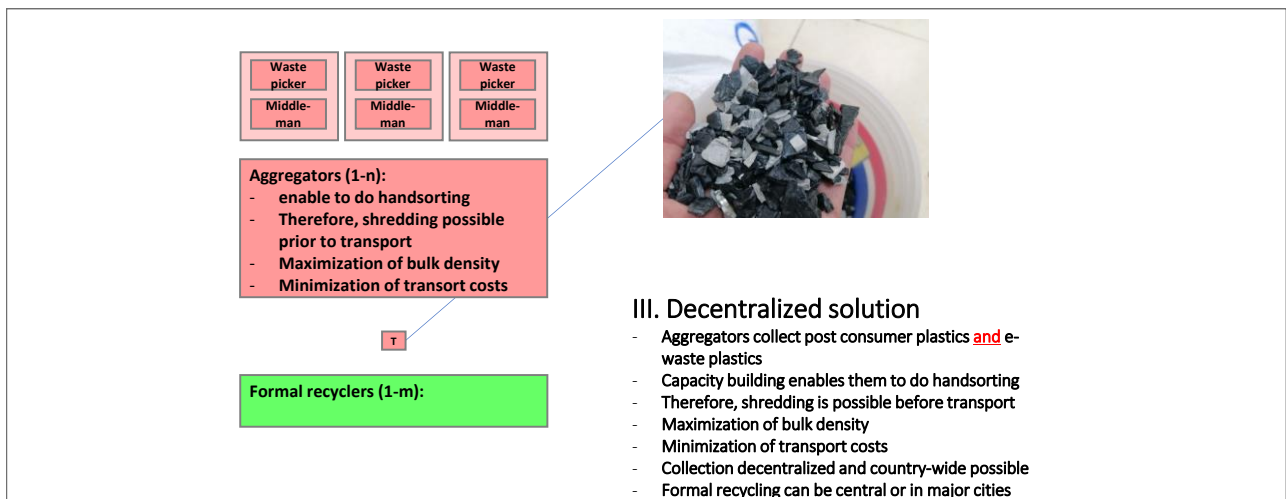
Figure 5-26 shows another possible collection method (II). It seems almost crucial to collect rather intact pieces. That causes a higher cost but makes proper identification possible and thus gives rise to a higher yield.

**Figure 5-26: Possible methods of collection I, II**



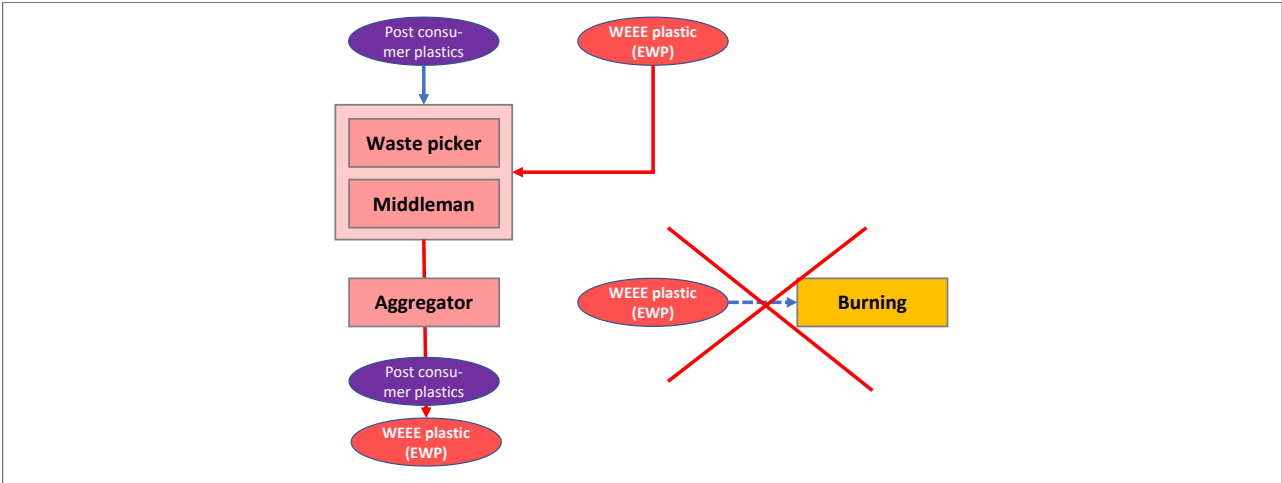
It is obvious that Method II will involve high transport costs. Considering the status of post-consumer plastic recycling (Figure 5-7) as well as the transport costs gives rise to a proposed collection method III. If collection, handsorting and shredding can be done decentralized by local aggregators a higher amount of WEEE plastics can be collected. Also transportation costs will be minimized.

**Figure 5-27: Possible methods of collection III**



Scenario III could give rise to an alternative future system for WEEE plastics. Aggregators can easily collect the WEEE plastics together with their current activities. As result the range to reach all available material can be much higher. Transport cost would be dramatically reduced and burning on site could be reduced dramatically.

**Figure 5-28: Possible scenario in collection system**



**Figure 5-29: Collection of post-consumer plastics together with WEEE plastics: necessary capacity building**

Collection			Recycling	
Waste Picker	Middleman	Aggregator	Recycling 1	Recycling 2
<ul style="list-style-type: none"> <li>- Individual</li> <li>- Collecting plastics from streets and dumps</li> <li>- <b>Capacity building: additional collection of WEEE plastics</b></li> </ul>	<ul style="list-style-type: none"> <li>- Buy plastics</li> <li>- Bag plastics</li> <li>- Sell</li> <li>- <b>Capacity building: additional collection of WEEE plastics</b></li> </ul>	<ul style="list-style-type: none"> <li>- Buy</li> <li>- Sort</li> <li>- <b>Sort EWP</b></li> <li>- Delabel</li> <li>- Wash</li> <li>- Cut</li> <li>- Shredd/ grind</li> <li>- <b>Capacity building: sorting of WEEE plastics</b></li> </ul>	<ul style="list-style-type: none"> <li>- Buy</li> <li>- Train aggreg.</li> <li>- Quality check</li> <li>- Float-sink sep.</li> <li>- Wash</li> <li>- dry</li> </ul>	<ul style="list-style-type: none"> <li>- Extrude/ pelletize</li> <li>- Coloring (Additivation)</li> </ul>
			<b>Recycling 1a</b> <ul style="list-style-type: none"> <li>- Train aggreg.</li> <li>- Quality check</li> <li>- <b>Float-sink separation with saltwater</b></li> <li>- Wash</li> <li>- dry</li> </ul>	



To enable the actors in that area GIZ has already started capacity building. In April 2022 a number of train the trainer sessions have taken place at the TTC operated by MESTI/ GIZ E-Waste Programme. Further sessions are in preparation (Figure 5-30)

**Figure 5-30: Train the trainer session on WEEE plastics recycling**



## 6. Applications of recycled WEEE plastics and economical feasibility

The economical feasibility is based on costs as of March 2022. The authors are aware of the fact that in the meantime there has been a dramatic inflation. At the time of this study the exchange rate was 7.5 GHS = 1€.

### 6.1. Price and application of virgin material

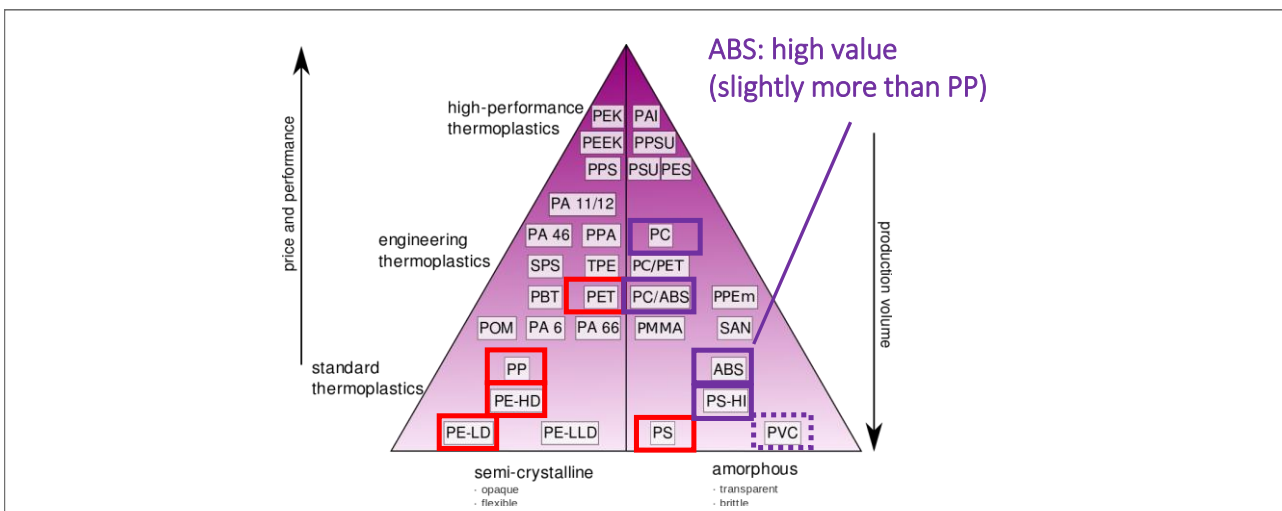
ABS is an engineering polymer that has mechanical properties exceeding those of polyolefins like impact resistance, toughness or rigidity.

ABS has the following chemical resistance:

- Resistant: aqueous acids, alkalis, concentrated hydrochloric acid, animal, vegetable and mineral oils
- Swollen by: concentrated acetic acid, aromatic hydrocarbons
- Low resistance: chlorinated solvents, alcohols and aldehydes

Figure 6-1 positions ABS and HIPS (PS-HI) in comparison to the standard polyolefins. ABS is comparable to PP and sells for a slightly higher price. HIPS is comparable to HDPE.

**Figure 6-1: Price and performance of plastics**



ABS has a similar price like Polypropylene. In 2022 the average market price for virgin material was between € 1,600 and 2,400 per tonne (GHS 12,000.- ... 18,000.- with exchange rate GHS 7.5/ € as of march 2022).



## 6.2. Business case 1: Collection, identification and flake production of ABS by aggregator

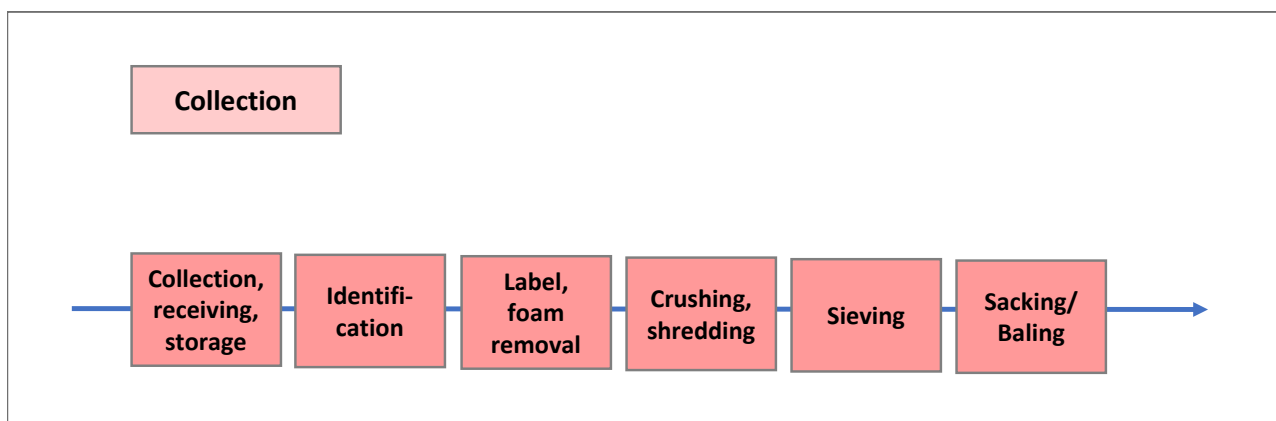
### 6.2.1. General Description and Specific Characteristics

As described in chapter 5.4 all the aggregators collecting material from their neighbourhood received “hard plastics” already that contain the valuable materials ABS and HIPS. Some PP from WEEE like vacuum cleaners is already collected anyway. In field visits several aggregators were interviewed. They all stated that it would be no problem at all to ask collectors and especially middleman to bring WEEE plastics according to application. The relevant applications have been described in chapter 5.1.1 already. This method has the advantage that plastics can be sourced locally without long transportation. It will then only be necessary to advise aggregators on how to separate the bulk items. The technologies described in chapter 4.3.2 will be applied.

### 6.2.2. Recommended Recycling Options

Figure 6-2 shows the process route for this case. After collection as bulk material and storage the items are separated according to application, label and then according to the limonene test. An acetone test doesn't seem necessary since PC and PC/ABS will be separated by the float-sink method. Taking out PP, PE and PVC is also not needed since these materials will later float or as in the case of PVC do not occur in the applications collected. Labels and pieces of foam are removed by hand or by knives. The items are then crushed by a cutlass or directly fed into the shredder. Hole sizes of the sieves should be in the order of 1-2 cm. If larger amounts are shredded it can be decided whether sorting according to colour can give rise to additional value. To get rid of sand and fine particles sieving must be done after shredding. This can easily be achieved by use of fishing nets or plastic mesh that is readily available on local markets. The flakes are bagged in 25 l bags and piled for transport.

**Figure 6-2: Collection, identification and flake production by aggregator**



### 6.2.3. Resulting Material Flow

It is assumed that existing aggregators collect WEEE plastics as additional feedstock and therefore also use existing equipment and facilities. In this calculation aggregators use 10 people for sorting on two days a week. Furthermore, they use their shredder on two days. These typically have a capacity of about 300 kg/h. We assume that they use their shredder for 5 hours per day. The remaining time will be used for cleaning, sharpening of the blades etc. This gives the following capacity:

$$\begin{aligned}
 300 \text{ kg/h} * 5\text{h/day} &= 1,500 \text{ kg/day} \\
 &= 3,000 \text{ kg/week} \\
 &= 12,000 \text{ kg/month} \\
 &= 144,000 \text{ kg/year}
 \end{aligned}$$

### 6.2.4. Economic Framework

Since such facilities already exist, we assume that shredding can be done according to prices that were found in field tests. They were in the range of GHS 0.35/kg shredded material. This gives rise to the following calculation:

• Buy WEEE plastics from middlemen or collectors 144,000 kg/year at a price of GHD 1.5/kg	GHS	216,000.-
• 10 workers * 2 days a week * 4 weeks/ months *12 months = 48 month at a price of GHS 1,000/month	GHS	48,000.-
• Shredder fee 144,000 kg/year * GHS 0.35/kg	GHS	50,400.-
	<b>GHS</b>	<b>314,400.-</b>

### 6.2.5. Employment opportunities

Since there are 5 aggregator needed to supply the flakes for one recycler the total employment opportunities are 5 \* 48 months / 12 = 20 workers. Additionally collectors are needed. We assume that they collect 50 kg/day or 10,000 kg/year. Therefore, for one aggregator 14 collectors are needed or for 5 aggregators 70 collectors.

The total employment opportunity for this business case is 90 workers per year.

Given a estimated potential of up to 2,250 tonnes per year of ABS and HIPS being recycled there is room for up to three recycling facilities and therefore 3 \* 5 =15 aggregators. Then the total employment opportunity is 3 \* 90 = 270 workers.

### 6.3. Business case 2: Depolluted (BFR-free and Polyolefin-free) ABS flakes

#### 6.3.1. General Description and Specific Characteristics

In this case one recycler will buy from 5 aggregators to supply his capacity.

As described in section 5.1.1 there is a potential for WEEE plastics recycling of 1,500 -2,250 tonnes of these plastics per year. The facility described in this case study has a capacity of 720 tonnes per year. One or two of these facilities could be in the Greater Accra Region and possibly another one in Kumasi or in Tamale.

**Figure 6-3: To feed one facility for depolluted ABS and HIPS 5 collectors/ aggregators are needed**

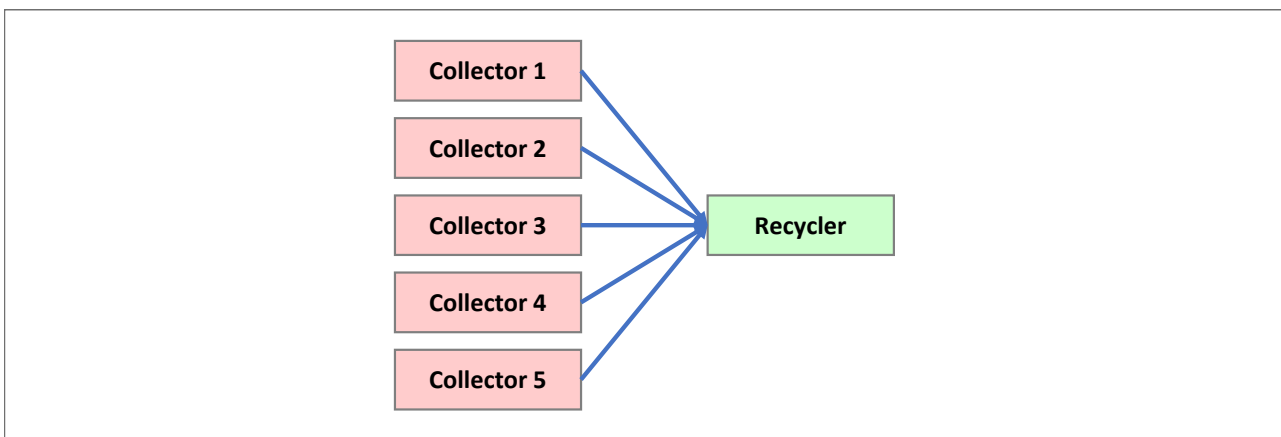


Figure 6-4 shows the process flow for this facility. Sacks with ABS flakes and HIPS flakes are collected from aggregators. In section 100 the material is received and checked for quality.

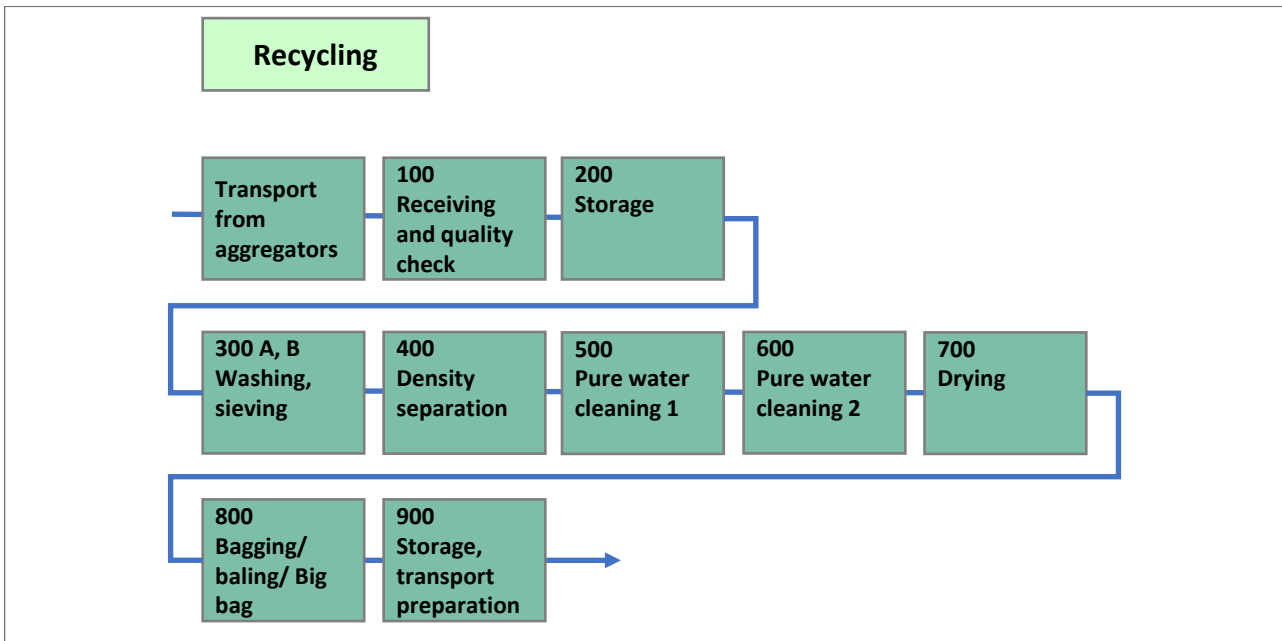
Section 200 is storage of raw material. For a one week production a capacity of 15 tonnes of material must be stored.

Washing is done in two parallel concrete mixers. We assume them to have a size of 150 l filled with 70 kg of flakes and 70 kg of water. After filling with flakes, washing powder and baking soda are added. The washing time is estimated to be 7 minutes. The suspension is discharged into a sieve. The water is either sent to the drain or reused. The discharge time is one minute. The cycle is:

- Filling flakes 2 minute
- Filling water, washing powder, baking soda 2 minute
- Rotate 7 minute
- Discharge 3 minute

The total time is about 14 minutes. 4 batches can be done within one hour giving 280 kg/h \* 2 mixers = 560 kg/h. Two workers are calculated for this step.

**Figure 6-4: Process flow for depolluted ABS/ HIPS**



After sieving the wet flakes are transferred to the float-sink tank (400). We propose to use an IBC that is cut open like in the TTC facility. It is filled with salt water with a density of 1.100 kg/l. The numbers are calculated with a filling of some 800 liters with flakes swimming on top with a layer of 10 cm height. This results in 100 l or about 50 kgs of flakes per batch. In order to enable every flake to sink if it is heavy enough, the suspension is stirred with a long wooden spoon for two minutes. Flakes are skimmed off with a sieve. They are then transferred to the first clean water station. The unwanted heavy flakes sink to the ground. Once a day the heavy flakes are removed from the bottom. Once a week the salt solution is replaced. The density is checked daily. The cycle is:

- Filling 2 minutes
- Stirring 2 minutes
- Sieving and transfer 2 minutes

As a clean water tank again an IBC is used (500). Since the good material will sink to the ground a net is inserted to the tank to remove the flakes after washing. Unwanted PE and PP particles are skimmed off before transferring the flakes to the next tank. With the net the flakes are moved up and down to wash them. The water is exchanged daily. The number of workers is 1.5

A second clean water tank (600) is necessary to achieve the necessary quality and remove the remaining salt. The principle is as in 500. The water has to be exchanged twice a day. 1.5 workers are needed.

The wet flakes are dried over night by placing them cloths. It is advisable to do that in a protected area where no dust can contaminate the product. After drying the flakes are bagged or baled and stored for transport.

The total amount of workers is

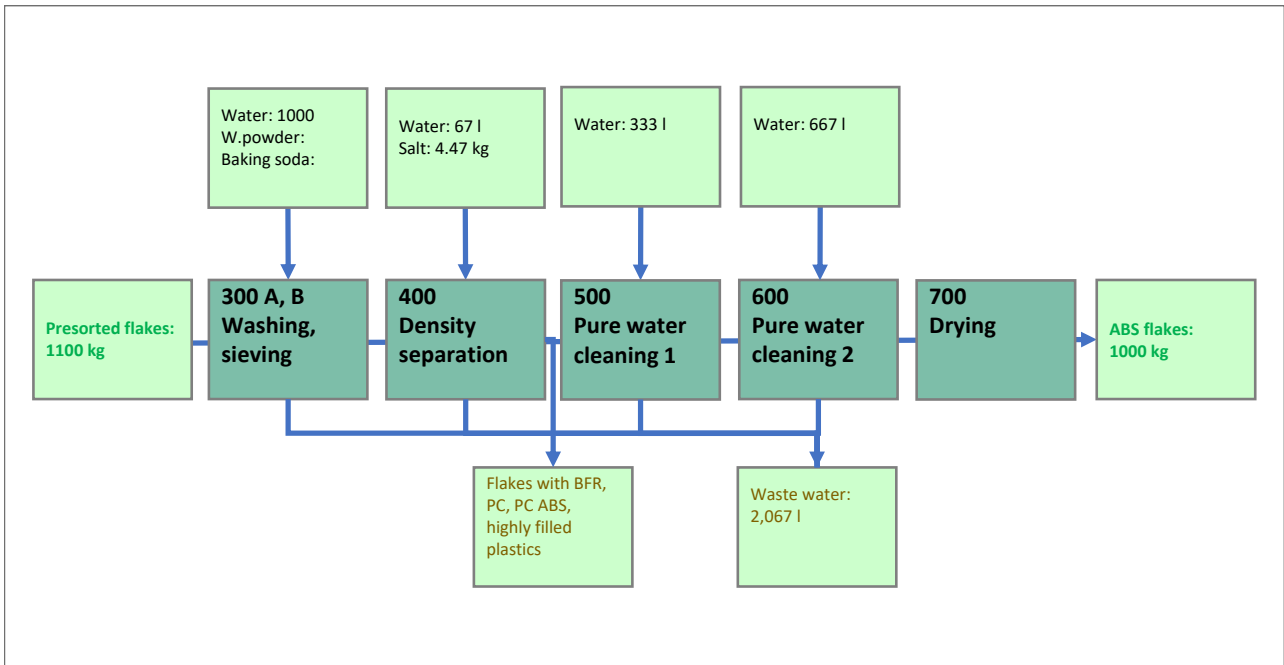
100	0.5 worker
200	0.5 worker
300	2 workers
400	2 workers
500	1,5 worker
600	1,5 worker
700	1 worker
800	1 worker
900	1 worker
<b>Total</b>	<b>11 workers</b>

Additionally, two supervisors and one manager are calculated.

### 6.3.2. Resulting Material Flow

The resulting material flow is shown in Figure 6-5 and is based on one ton of product.

**Figure 6-5: Material flow for depolluted ABS/ HIPS**



### **6.3.3. Economic Framework**

With these numbers the production costs were calculated.

A detailed business-case evaluation is under way and is most likely to be put into operation. The numbers available are very promising.

### **6.3.4. Employment opportunities**

The number of employees is:

- 11 workers
- 1 technician
- 2 foremen
- 2 drivers
- 1 manager

A total of 17 jobs can thus be created. For three facilities of this kind in Ghana there could be a total job creation of  $3 * 17 = 51$  job. Considering the preceding case for the aggregators together with this one a total of  $270 + 51 = 321$  jobs can be created.

## **6.4. Business case 3: Extrusion of flakes, pelletization**

### **6.4.1. General Description and Specific Characteristics**

Typically the bigger plastic processors operate their own extrusion lines for recycled material. Before processing their products they mix recycled material with virgin material. Small scale informal recyclers could also do extrusion. However, the quality control and management can only be done if there is control of the flakes. Therefore, it is rather unlikely that plastic processors buy ready made pellets. We therefore assume that one or more of the big plastic processors open an additional small extruder with a capacity of about 1 tonne per hour in their existing facilities. They will source ABS on the international market and replace 50% of the virgin material by recycled material. The market price is between € 1,500 and € 2,000 per tonne. With the conversion rate considered here this is equivalent to 11,250 – 15,000 GHS/t. We estimated a small used extruder plus the granulation facility to cost about GHS 675,000.-. This includes a used extruder, underwater strand extrusion and pelletization. The costs for raw material are the one from the previous case. We assume 400 kJ/kg heating and melting enthalpy giving a consumption of 0.11 kWh/kg for the extruder.

### **6.4.2. Resulting Material Flow**

1,000 tonnes per year of ABS flakes will be used, mixed with 1,000 t/y of virgin material to give 2,000 t/y finished product.

### **6.4.3. Economic Framework**

With these numbers the production costs were calculated.

A detailed business-case evaluation is under way and is most likely to be put into operation. The numbers available are very promising.

### 6.5. Business case 4: Export of depolluted ABS flakes to Europe

The export of depolluted flakes is currently investigated with a WEEE recycler. In Europe there are a number of recycling companies selling recycled ABS, HIPS and PP from WEEE. This is due to the legislation that requires WEEE to be collected and recycled. Therefore a market for recycled WEEE plastics exist. Furthermore, the market works different in Europe. Consumers want to “do something for the environment” and want recycled products. When using plastics in consumer products it is possible that the price of recycle is higher than that of virgin material.

Transport costs were estimated based on a 40 foot container. This container can transport about 22 t of material. At the time of estimation the costs for a container from Tema to Antwerpen was \$ 1,500. The transport of this container from Antwerpen to Vienna, Austria was € 2,450.-.

**Table 6-1: Transportation costs for export of flakes to Europe**

Transport	€ or \$	GHS*	GHS/tonne	€/tonne
Container Tema Antwerpen, Netherlands	1500	11250	511	68
Container on truck Antwerpen - Vienna	2450	18375	835	111
* based on 7.5 GHS = 1 €, march 2022			<b>1347</b>	<b>180</b>

A total of about GHS 1,347.- or € 180.- has to be added to market flakes in Europe. The challenge for the export are especially the necessary papers and the notification. Since the material is depolluted this is possible in principle. To send some few 40 foot container with 22 tonnes each is in preparation. After that the business case can be further evaluated.

### 6.6. Business case 5: Export of depolluted ABS flakes to West African countries

In case there were no use by Ghanaian companies or by exporting to Europe, it is also possible to export flakes to other West African countries. There is a existing market for recyclates and also products made from recycled plastics in Nigeria. It will be worth taking a closer look here or teaming up with international organizations being active in Nigeria already.

### 6.7. Business case 6: Other applications

In the European Union between 60-100,000 tonnes per year of post-consumer plastics from WEEE are being used. Often, the products are not made entirely out of recycled plastics but rather to a certain percentage. Applications include



- Printers
- Notebooks
- TVs
- Coffee machines
- Vacuum cleaners

According to the processing methods described previously there are a number of possible applications that can now be evaluated with the material properties available from this study. The following paragraph gives a summary of possibilities. It must be noted that they all require extrusion/ pelletization prior to processing.

- Plastic sheets for thermoforming and vacuum forming
- Plumbing parts, e.g. drain-waste vent
- Sockets
- Small kitchen appliances: coffee machine, Vacuum cleaner housing
- Interior parts for automotive assemblers in Ghana

- **Plastic sheets or boards for thermoforming and vacuum forming**

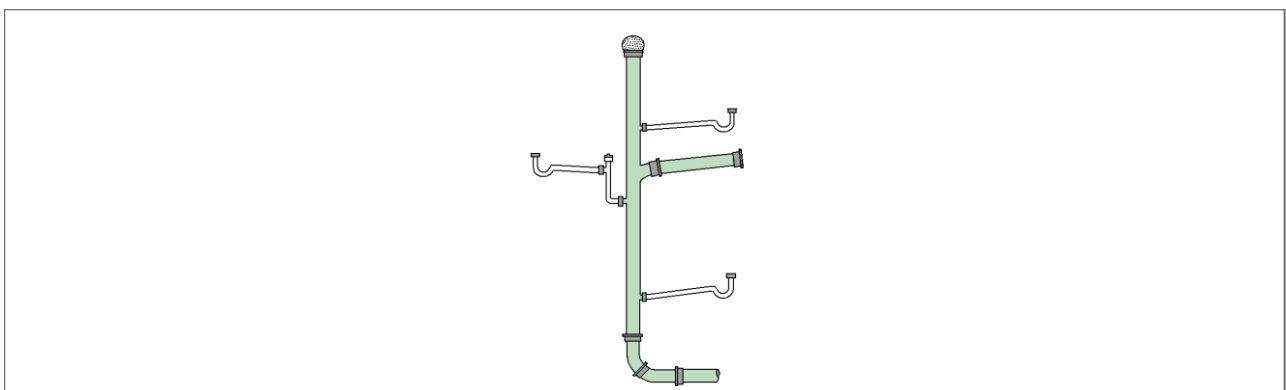
A very simple and low-tech application is the production of plastic sheets. The melt of an extruder can be directly injected into the sheet. Alternatively pellets are used. Sheets can be used for vacuum forming or can be machined directly after softening with a heat source. This makes it especially suitable for small workshops, car repairers etc.

- **Plumbing parts, e.g. drain-waste vent**

Plumbing parts can be produced by injection moulding or extrusion. The following figure gives an example.

---

**Figure 6-6: Drain-waste-vent**



- **Sockets**

Sockets and any other simple part that requires high impact resistance can be made from ABS and HIPS by injection moulding.

- **Interior parts for automotive assemblers in Ghana**

In Ghana there are five companies that assemble cars in local factories. There are a lot of interior car parts made from ABS or HIPS. These include arm rest, dashboard, parts of steering wheels, door parts etc. Manufacturers should be approached to use locally recycled material in their products. The companies assembling in Ghana are:

- Volkswagen (VW),
- Nissan,
- Toyota,
- Kantanka,
- Sinotruck.

## 7. Impact analysis

The three categories of impact also define the three pillars of sustainability. We have found the following impacts.

### 7.1. Social

By implementing the business cases that have been calculated in detail and described in chapters 6.2 - 0 a total number of 335 jobs can be generated.

Considering the whole value chain and assuming a total capacity of 2,100 t/y, there is potential business for two recyclers with a capacity of 1,050 tonnes per year each. In this case the total value chain would be:

• Collection and aggregation	270
• Depolluted flakes	51
• Extrusion/ pelletization	14
<hr/>	
<b>total</b>	<b>335</b>

Most of the workers in collection and aggregation will be from the informal sector while the employment opportunities for depollution and extrusion/pelletization come from formal recycling companies.

### 7.2. Economic

The business cases described are economically feasible cases. Market and industry will therefore automatically start implementing these methods without any further state regulation. A total revenue of GHS/t 11,250.- \* 2,100 t/y = 23,625,000.- can be generated. The price basis for our calculation is March 2022 with an exchange rate of GHS 7.5 = € 1. Therefore, the equivalent in Euros is 3,150,000.- per year.

### 7.3. Environmental

A life-cycle assessment performed by ABS [Røyne et al.] found a value of 3.2 kg CO<sub>2</sub> emissions per one kilogramme ABS. The aim of this work is not to give a detailed life cycle analysis. However, we want to estimate a rough number for the climate impact and assume the following:

- Electricity consumption is about 0.03 kWh/kg for depolluting+ 0.11 kWh/kg for extrusion = 0.14 kWh/kg ABS
- Since we did not assess the fuel consumption for transport we assume a total energy consumption of 0.2 kWh/kg ABS

- According to the International Energy Agency (IEA) the total emissions of CO<sub>2</sub> in 2019 were 18.15 per year. The electricity production is mainly based on fossil fuels according to that source. Hydropower contributes only 5% of the energy consumption. The total electricity being consumed was 13.5 TWh. This gives a calculated value of 1.34 kg CO<sub>2</sub>/kWh.

With these number the CO<sub>2</sub> emission due to the recycling process are 0.268 kg CO<sub>2</sub> equivalent/ kg ABS. The recyclate thus saves 2.932 kg CO<sub>2</sub> equivalent/ kg ABS and in total for 2,100 tonnes per year or 6,157 tonnes CO<sub>2</sub> equivalent.

Furthermore, the emission of toxic substances due to incineration in low-temperature open fires can be reduced considerably.

#### **7.4. Contribution to the goals of the GIZ e-waste programme**

The following contributions to the goals of the MESTI/ GIZ E-waste programme are to be expected

##### **1) Investment into technical recycling solutions**

It is highly likely that businesses will invest into the technologies described here thus making a substantial contribution to business development.

##### **2) Training and Capacity building on company level**

The technologies described here have been already shared by train the trainer programmes on different occasions. This activity will continue as an ongoing effort.

##### **3) Redirection of material flow from informal to formal sector to prevent the history of the Old Fadama Scrap Yard to occur again and to establish a sustainable E-Waste management system in Ghana**

By making use of recyclates burning of plastics will be reduced. Furthermore, the substances that will be separated during the depollution step will be directed to landfills.

## List of References

Bening, C.R.; Kahlert, S.; Asiedu, E. "The true cost of solving the plastic waste challenge in developing countries: the case of Ghana, *Journal of Cleaner Production*, 330, (2022)

Bill, A.; Gasser, M.; Haarman, A.; Böni, H., Empa, Switzerland, *Processing of WEEE plastics A practical handbook*; EMPA Switzerland 2019, ISBN 978-3-906177-22-9

IEA 2022 <https://www.iea.org/countries/ghana> downloaded on 2022-10-25

Kobler, R., Foss, H., 2004. Successful recovery of end of life electronics plastics using RPI's sink flotation technology. *Recovery Plastics International (RPI)*, GPEC 2004 Paper Abstract #32

Mohammed, L.: Policy framework and stakeholder capacity of e-waste thermoplastics management in Ghana; study elaborated on behalf of the MESTI/ GIZ E-Waste Programme; Accra, October 2022

Peeters, J.R., Vanegas, P., Tange, L., Van Houwelingen, J., Dufloy, J.R., 2014. Closed loop recycling of plastics containing Flame Retardants. *Resour. Conserv. Recycl.* 84, 35–43. doi:10.1016/j.resconrec.2013.12.006 (cited in *Managing hazardous additives in WEEE plastic from the Indian informal sector A study on applicable identification & separation methods* Arthur Haarman, Michael Gasser June 2016)

Røyne, F.; Berlin, J.; The importance of including service life in the climate impact comparison of bioplastics and fossil-based plastics; *RISE Report 2018:23*

Wäger, P.; Hischer, R.; Life cycle assessment of post-consumer plastics production from waste electrical and electronic equipment (WEEE) treatment residues in a Central European plastics recycling plant; *Science of the Total Environment* 529 (2015), 158-167

Zweifel, H., Maier, R.D.; M.; *Plastics Additives Handbook*, Hanser 6<sup>th</sup> edition, 2009

